

JVC



AUDIO/VIDEO CONTROL RECEIVER

AV功率放大器 (带收音)

RX-669PGD

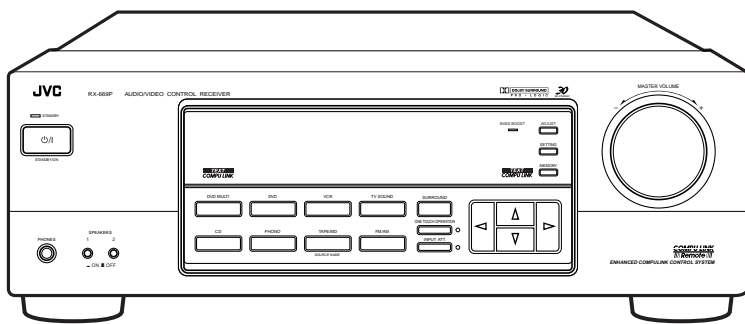
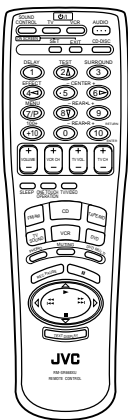

**TEXT
COMPU LINK**

**COMPU LINK
Remote**

**3D
3D-PHONIC**

**DOLBY SURROUND
PRO • LOGIC**

INSTRUCTIONS

使用说明书

For Customer Use:

Enter below the Model No. and Serial No. which are located either on the rear, bottom or side of the cabinet. Retain this information for future reference.

Model No. _____

Serial No. _____

LVT0142-006A
[UB]

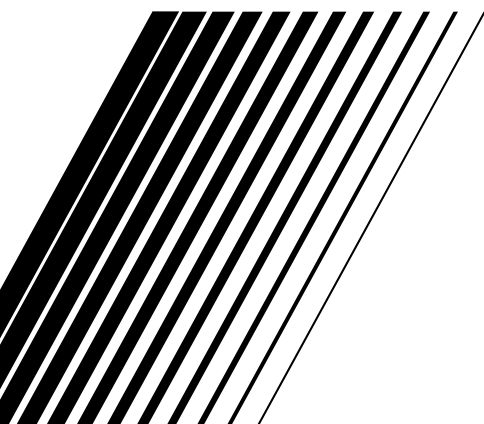

Warnings, Cautions and Others / Avisos, precauciones y otras notas / Advertências, precauções e outras notas / 警告，注意及其他须知事项

تحذيرات، تنبيهات وأشياء أخرى

CAUTION

To reduce the risk of electrical shocks, fire, etc.:

1. Do not remove screws, covers or cabinet.
2. Do not expose this appliance to rain or moisture.

PRECAUCIÓN

Para reducir riesgos de choques eléctricos, incendio, etc.:

1. No extraiga los tornillos, los cubiertas ni la caja.
2. No exponga este aparato a la lluvia o a la humedad.

ATENÇÃO

Para reduzir riscos de choques elétricos, incêndio, etc.:

1. Não retire parafusos nem desmonte as tampas ou o gabinete.
2. Não exponha este aparelho à chuva nem à umidade.

警告

为了减低触电，火灾等危险：

1. 请勿擅自卸下螺丝钉，盖子或机壳。
2. 切勿让本机受雨淋或置潮湿环境中。

تحذير

لتجنب خطر الحريق، الصدمات الكهربائية، الخ.:

1. لا تقم بفك البراغي، الاغطية أو الخزانة.
2. لا تقم بتعرض هذا الجهاز للمطر أو للرطوبة.

Caution — ⏻/⏻ switch!

Disconnect the mains plug to shut the power off completely. The ⏻/⏻ switch in any position does not disconnect the mains line. The power can be remote controlled.

Precaución — Interruptor ⏻/⏻!

Desconectar el cable de alimentación para desactivar la alimentación totalmente. Cualquiera que sea la posición de ajuste del interruptor ⏻/⏻, la alimentación no es cortada completamente. La alimentación puede ser controlada remotamente.

Precaução — Interruptor ⏻/⏻!

Desconectar o cabo de alimentação para desligar a alimentação por completo. Qualquer que seja a posição de ajuste do interruptor ⏻/⏻, a alimentação não é completamente cortada. A alimentação pode ser controlada remotamente.

注意— ⏻/⏻ 开关！

无论 ⏻/⏻ 开关在任何位置，电源线的电源还是没有被切断，若要将电源完全关闭，应把电源插头拔离插座。电源开关可用遥控器控制。

تحذير — ⏻/⏻ الطاقة

انزع قابس الطاقة الكهربائية من أجل فصل الطاقة الكهربائية عن الجهاز كلياً. لا يفصل مفتاح الطاقة الكهربائية عندما يكون باي وضع ⏻/⏻ الطاقة الكهربائية عن الجهاز. يمكن التحكم عن بعد بالطاقة الكهربائية.

Caution: Proper Ventilation

To avoid risk of electric shock and fire and to protect from damage.

Locate the apparatus as follows:

- Front: No obstructions open spacing.
 Sides: No obstructions in 10 cm from the sides.
 Top: No obstructions in 10 cm from the top.
 Back: No obstructions in 15 cm from the back.
 Bottom: No obstructions, place on the level surface.

In addition, maintain the best possible air circulation as illustrated.

Precaución: Ventilación Adecuada

Para evitar el riesgo de choque eléctrico e incendio y para proteger el aparato contra daños.

Ubique el aparato de la siguiente manera:

- Frente: Espacio abierto sin obstrucciones
 Lados: 10 cm sin obstrucciones a los lados
 Parte superior: 10 cm sin obstrucciones en la parte superior
 Parte trasera: 15 cm sin obstrucciones en la parte trasera
 Fondo: Sin obstrucciones, colóquelo sobre una superficie nivelada

Además, mantenga la mejor circulación de aire posible como se ilustra.

Precaução: ventilação apropriada

Para prevenir o risco de choque elétrico ou incêndio e para proteger o aparelho contra danos.

Localize-o da seguinte maneira:

- Frente: Espaço aberto, sem obstruções
 Lados: Espaço de 10 cm sem obstruções nos lados
 Topo: Espaço de 10 cm sem obstruções acima
 Atrás: Espaço de 15 cm sem obstruções atrás
 Parte inferior: Sem obstruções. Coloque o aparelho em superfície nivelada.

Mantenha, além disso, a maior circulação de ar possível, como indica a ilustração.

注意：正确的通风方法

为了防止触电、火灾以及避免损坏，

按如下要求放置机器：

- 前面：留下空间不要放置障碍物。
 侧面：侧面的 10cm 之内不要放置障碍物。
 上面：上面的 10cm 之内不要放置障碍物。
 背面：背面的 15cm 之内不要放置障碍物。
 底部：不要放置障碍物、水平放置。

此外，如图所示，尽可能保持最佳的空气循环。

تنبيه: حول التهوية الصحيحة

لتفادي وقوع الصدمة الكهربائية والحريق، ولحماية الأجهزة من التلف قم بتحديد مواقع تركيب الأجهزة كالتالي:

- الامام: مساحة فارغة بدون عوائق
 الجوانب: عدم وجود أية عوائق بطول ١٠ سم من الجوانب
 السطح العلوي: عدم وجود أية عوائق بطول ١٠ سم من السطح العلوي
 الخلف: عدم وجود أية عوائق بطول ١٥ سم من اللوحة الخلفية
 القاع: عدم وجود أية عوائق، يجب وضع الأجهزة على السطح المستوي.
 بالإضافة الى ذلك، احتفظ بأفضل توزيع للهواء كما هو مبين في الرسم.

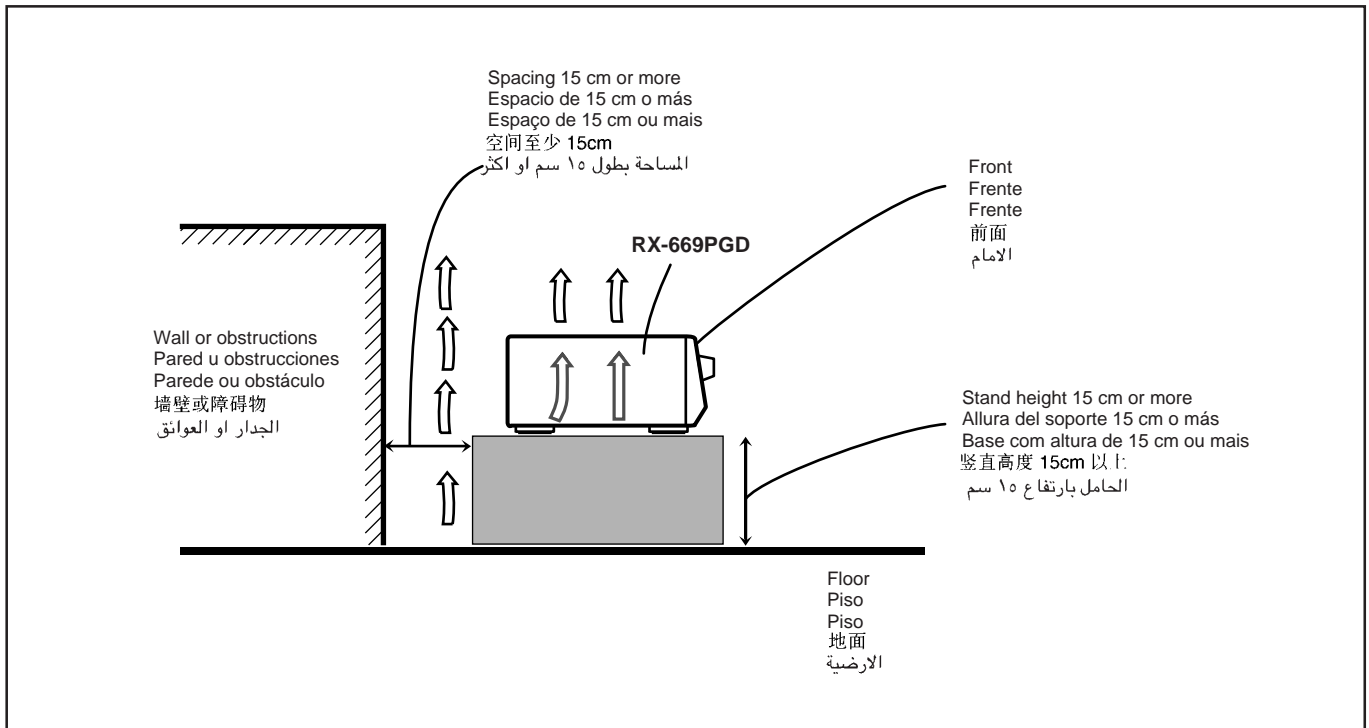
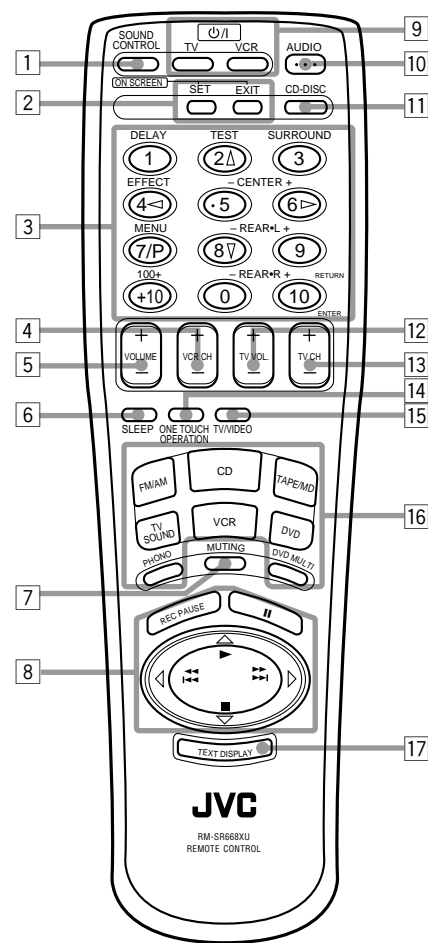
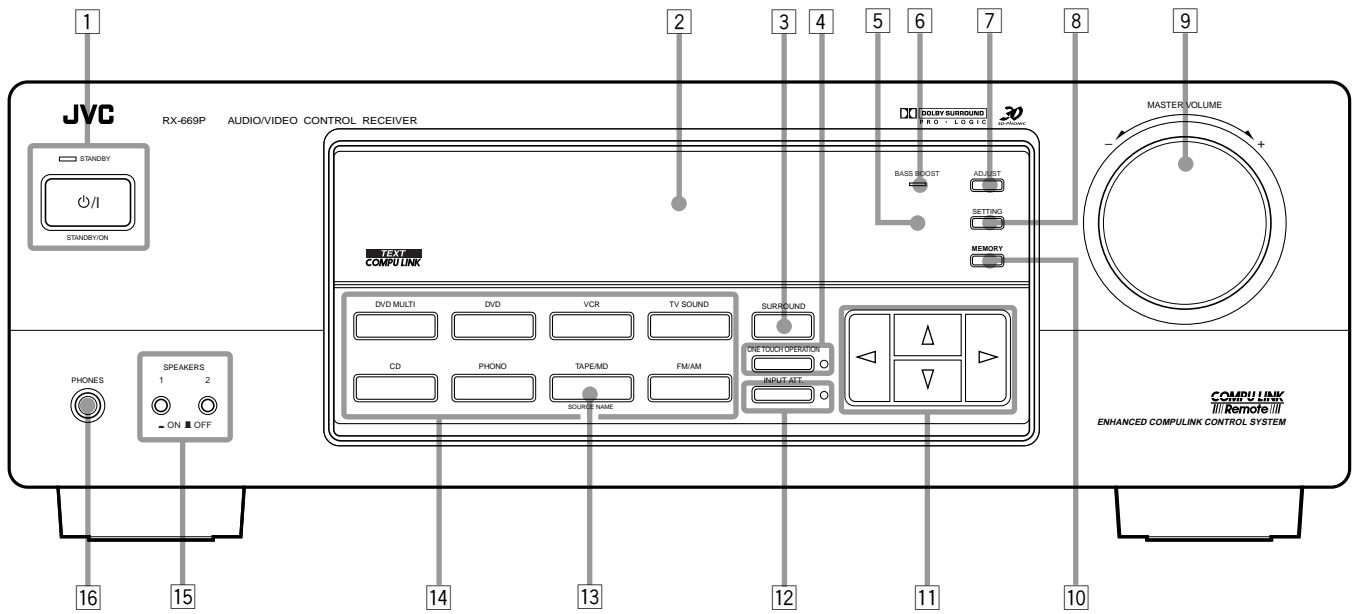

Table of Contents

Parts Identification	2	Using the DSP Modes	15
Getting Started	3	Available DSP Modes According to the Speaker Arrangement ..	16
Before Installation	3	Adjusting the 3D-PHONIC Modes	17
Checking the Supplied Accessories	3	Adjusting the DAP Modes	17
Setting the Voltage Selector Switch	3	Adjusting the Surround Modes — Dolby Surround and JVC Theater Surround	18
Connecting the FM and AM Antennas	3	Activating the DSP Modes	19
Connecting the Speakers	4	Using the DVD MULTI Playback Mode	20
Connecting Audio/Video Components	5	Activating the DVD MULTI Playback Mode	20
Connecting the Power Cord	7	Using the On-Screen Menus	21
Putting Batteries in the Remote Control	7	Selecting the Source to Play	21
Basic Operations	8	Using the DSP Modes	21
Turning the Power On and Off (Standby)	8	Adjusting the Front Speaker Output Balance	21
Selecting the Source to Play	8	Reinforcing the Bass	22
Adjusting the Volume	9	Attenuating the Input Signal	22
Selecting the Front Speakers	9	Attenuating the DSP Modes	22
Muting the Sound	9	Adjusting the DVD MULTI Playback Modes	23
Recording a Source	9	Adjusting the Tone	23
Attenuating the Input Signal	10	Setting the Basic Setting Items	23
Adjusting the Front Speaker Output Balance	10	Operating the Tuner	24
Reinforcing the Bass	10	Storing the Preset Stations	24
Adjusting the Tone	10	COMPU LINK Remote Control System	25
Basic Settings	11	TEXT COMPU LINK Remote Control System ..	26
Changing the Source Name	11	Showing the Disc Information on the TV Screen	27
Setting Center and Rear Speakers for the DSP Modes	11	Searching a Disc (Only for the CD player)	28
Using the Sleep Timer	12	Entering the Disc Information	29
Storing the Basic Settings and Adjustments — One Touch Operation	12	Operating JVC's Audio/Video Components ...	31
Receiving Radio Broadcasts	13	Troubleshooting	33
Setting the AM Tuner Interval Spacing	13	Specifications	34
Tuning in Stations Manually	13		
Using Preset Tuning	13		
Selecting the FM Reception Mode	14		

Parts Identification

Become familiar with the buttons and controls on the receiver before use.
Refer to the pages in parentheses for details.



Front Panel

- 1 STANDBY/ON \odot/I button and STANDBY lamp (8)
- 2 Display (8)
- 3 SURROUND button (17)
- 4 ONE TOUCH OPERATION button and lamp (12)
- 5 Remote sensor (7)
- 6 BASS BOOST lamp (10)
- 7 ADJUST button (10) *
- 8 SETTING button (11) *
- 9 MASTER VOLUME control (9)
- 10 MEMORY button (13)
- 11 Cursor control buttons
- 12 INPUT ATT. button and lamp (10)
- 13 SOURCE NAME button (11)
- 14 Source selecting buttons (8)
DVD MULTI, DVD, VCR, TV SOUND, CD, PHONO, TAPE/MD, FM/AM *
- 15 SPEAKERS 1/2 buttons (9)
- 16 PHONES jack (9)

Remote Control

- 1 SOUND CONTROL button (19, 31)
- 2 ON SCREEN operation buttons (21)
SET, EXIT
- 3
 - 10 keys for selecting preset channel (14)
 - 10 keys for adjusting sound (17 – 20)
 - 10 keys for operating audio/video components (31)
 - On-screen operation buttons (Δ , ∇ , \triangleleft , \triangleright) (21, 27)
- 4 VCR CH +/- button (32)
- 5 VOLUME +/- button (9)
- 6 SLEEP button (12)
- 7 MUTING button (9)
- 8 Operating buttons for audio/video components (31)
- 9 \odot/I buttons (32)
TV, VCR
- 10 AUDIO button (8)
- 11 CD-DISC button (31)
- 12 TV VOL. +/- button (32)
- 13 TV CH +/- button (32)
- 14 ONE TOUCH OPERATION button (12)
- 15 TV/VIDEO button (32)
- 16 Source selecting buttons (8)
FM/AM, CD, TAPE/MD, TV SOUND, VCR, DVD, PHONO, DVD MULTI
- 17 TEXT DISPLAY button (27)

IMPORTANT:

To use the Cursor control buttons (11) on the front panel:

What these buttons actually do depends on which function you are trying to adjust. Before using these buttons, select the function by pressing one of the buttons marked with *.

Getting Started

This section explains how to connect audio/video components and speakers to the receiver, and how to connect the power supply.

Before Installation

General

- Be sure your hands are dry.
- Turn the power off to all components.
- Read the manuals supplied with the components you are going to connect.

Locations

- Install the receiver in a location that is level and protected from moisture.
- The temperature around the receiver must be between -5° and 35° C (23° and 95° F).
- Make sure there is good ventilation around the receiver. Poor ventilation could cause overheating and damage the receiver.

Handling the receiver

- Do not insert any metal object into the receiver.
- Do not disassemble the receiver or remove screws, covers, or cabinet.
- Do not expose the receiver to rain or moisture.

Checking the Supplied Accessories

Check to be sure you have all of the following items, which are supplied with the receiver.

The number in the parentheses indicates quantity of the pieces supplied.

- Remote Control (1)
- Batteries (2)
- AM Loop Antenna (1)
- FM Antenna (1)

If anything is missing, contact your dealer immediately.

Setting the Voltage Selector Switch

Before connections, always set the voltage selector switch first if necessary.

Set the correct voltage for your area with the voltage selector switch on the rear panel.

Use a screw driver to rotate the switch so the number the arrow is pointing at is the same as the voltage where you are plugging in the receiver.

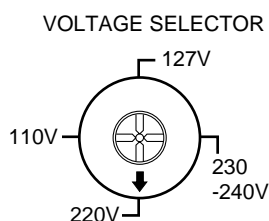

Connecting the FM and AM Antennas

FM Antenna Connections

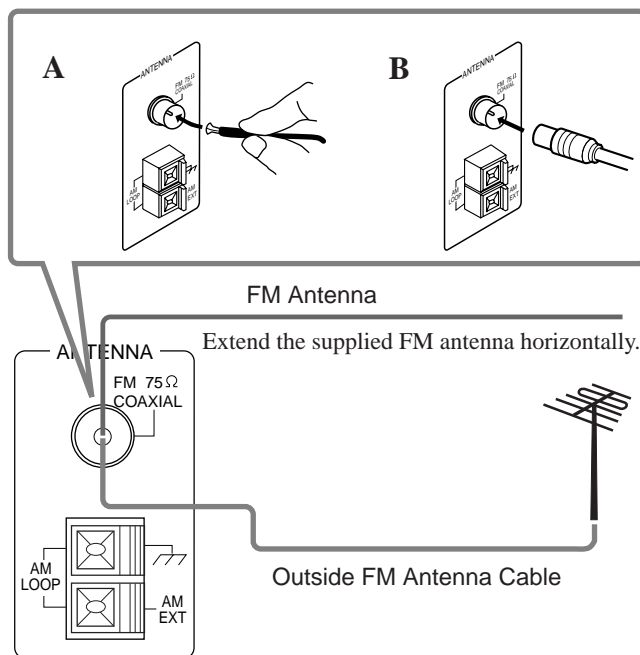

A. Using the Supplied FM Antenna

The FM antenna provided can be connected to the FM 75Ω COAXIAL terminal as temporary measure.

B. Using the Standard Type Connector (Not Supplied)

A standard type connector should be connected to the FM 75Ω COAXIAL terminal.

Note:

If reception is poor, connect the outside antenna. Before attaching a 75Ω coaxial cable (the kind with a round wire going to an outside antenna), disconnect the supplied FM antenna.

AM Antenna Connections

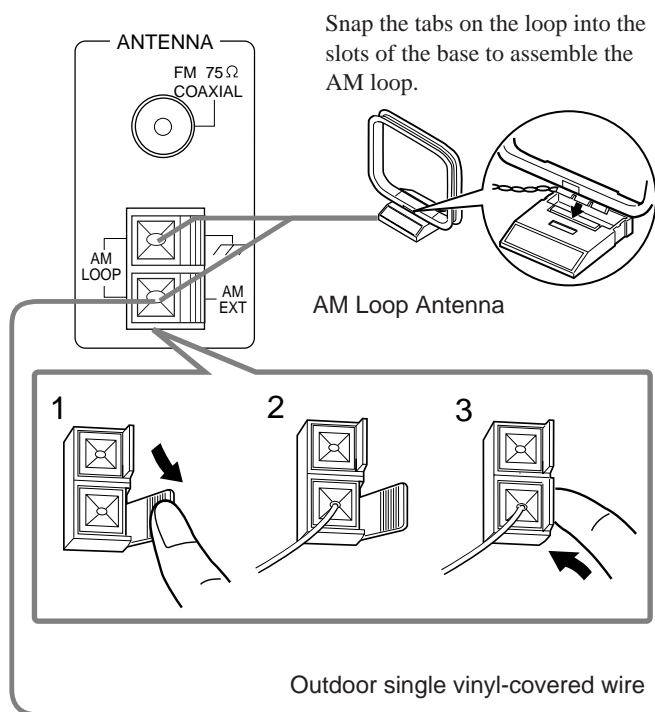

Turn the loop until you have the best reception.

Notes:

- Make sure the antenna conductors do not touch any other terminals, connecting cords and power cord. This could cause poor reception.
- If reception is poor, connect an outdoor single vinyl-covered wire to the AM EXT terminal. (Keep the AM loop antenna connected.)

Connecting the Speakers

You can connect the following speakers:

- Two pairs of front speakers to produce normal stereo sound.
- One pair of rear speakers to enjoy the surround effect.
- One center speaker to produce more effective surround effect (to emphasize human voices).
- One subwoofer to enhance the bass.

IMPORTANT:

After connecting the speakers listed above, set the speaker setting information properly to obtain the best possible surround effect. For details, see page 11.

For each speaker (except for a subwoofer), connect the (-) and (+) terminals on the rear panel to the (-) and (+) terminals marked on the speakers. For connecting a subwoofer, see page 5.

CAUTION:

Use speakers with the SPEAKER IMPEDANCE indicated by the speaker terminals.

Basic connecting procedure

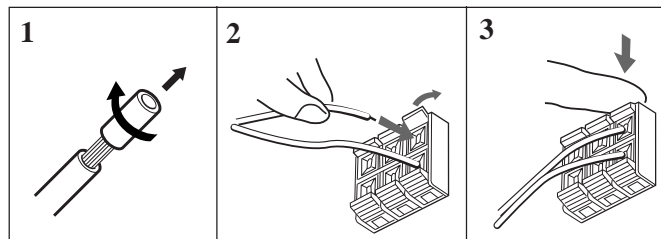

- 1 Cut, twist and remove the insulation at the end of each speaker signal cable.
- 2 Open the terminal and then insert the speaker signal cable.
- 3 Close the terminal.

Connecting the front speakers

You can connect two pairs of front speakers (one pair to the FRONT SPEAKERS ① terminals, and another pair to the FRONT SPEAKERS ② terminals).

Right speaker — FRONT SPEAKERS ① — Left speaker

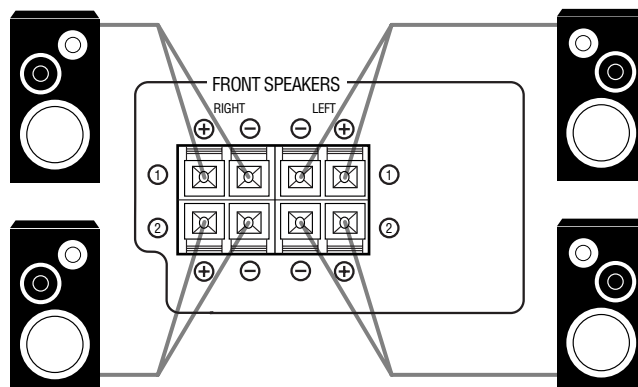

Right speaker — FRONT SPEAKERS ② — Left speaker

Connecting the rear and center speakers

Connect rear speakers to the REAR SPEAKERS terminals and a center speaker to the CENTER SPEAKER terminals.

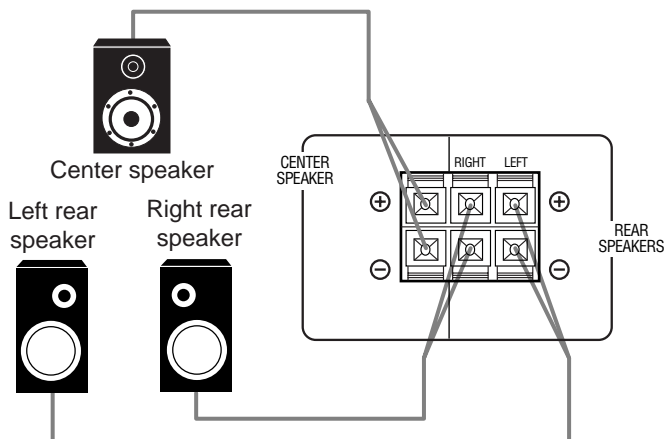

Connecting the subwoofer speaker

You can enhance the bass by connecting a subwoofer. Connect the input jack of a powered subwoofer to the SUBWOOFER OUT jack on the rear panel, using a cable with RCA pin plugs.



Powered subwoofer

Connecting Audio/Video Components

You can connect the following audio/video components to this receiver using cables with RCA pin plugs (not supplied). Refer also to the manuals supplied with your components.

Audio component connections

Use the cables with RCA pin plugs (not supplied). Connect the white plug to the audio left jack, and the red plug to the audio right jack.

CAUTION:

If you connect a sound-enhancing device such as a graphic equalizer between the source components and this receiver, the sound output through this receiver may be distorted.

CD player

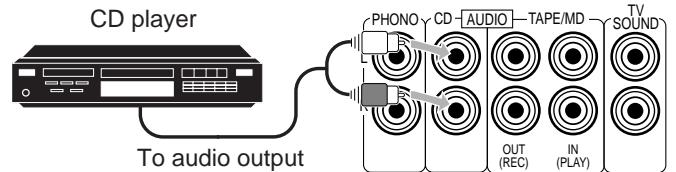

Cassette deck or MD recorder

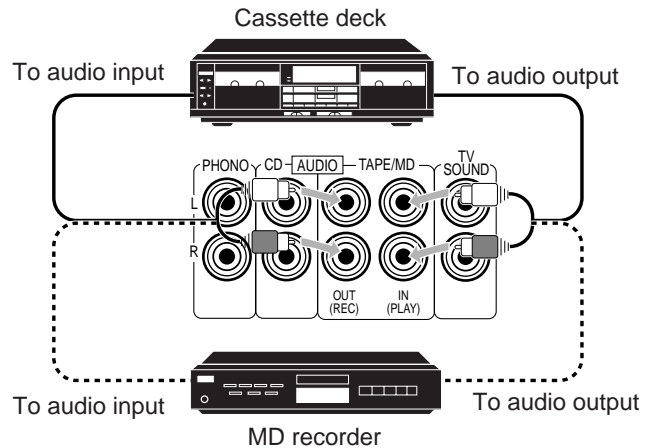

Note:

You can connect either a cassette deck or an MD recorder to the TAPE/MD jacks. When connecting an MD recorder to the TAPE/MD jacks, change the source name, which will be shown on the display when selected as the source, to "MD." See page 11 for details.

TV (as the sound source)

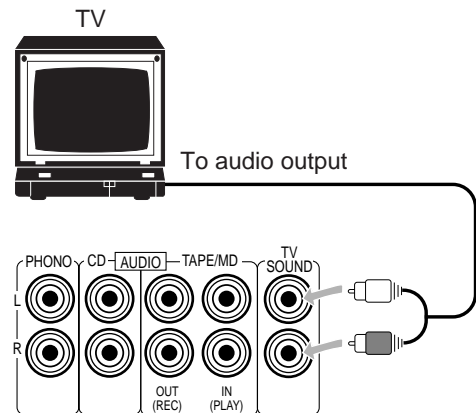

Turntable

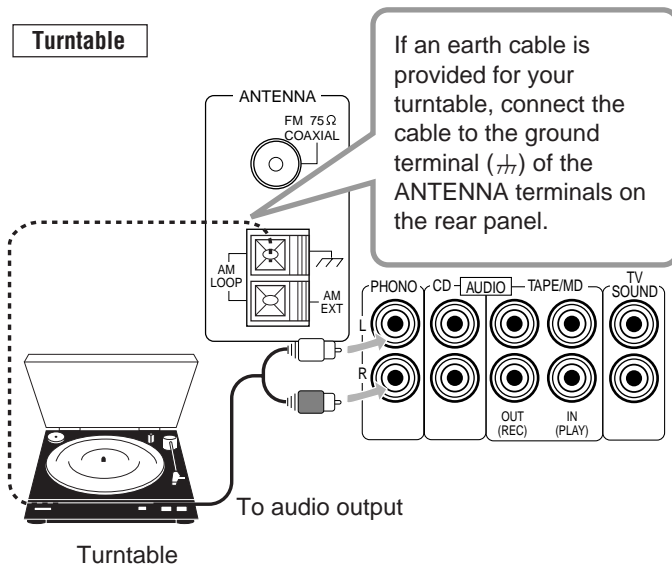

Note:

Any turntables incorporating a small-output cartridge such as an MC (moving-coil type) must be connected to this receiver through a commercial head amplifier or step-up transformer. Direct connection may result in insufficient volume.

If your audio components have a COMPU LINK-3 or TEXT COMPU LINK terminal

- See also page 25 for detailed information about the connection and the COMPU LINK-3 remote control system.
- See also page 26 for detailed information about the connection and the TEXT COMPU LINK remote control system.

Video component connections

Use the cables with RCA pin plugs (not supplied). Connect the white plug to the audio left jack, the red plug to the audio right jack, and the yellow plug to the video jack. If DVD player and TV have S-video (Y/C-separation) terminals, connect them using S-video cables (not supplied). Connecting these video components through the S-video input/output terminals will give you better picture playback quality.

IMPORTANT:

This receiver is equipped with both the composite video and S-video input terminals for the DVD player connection.

You do not have to connect both the composite video and S-video terminals.

However, **remember that the video signals from the composite video input terminal are output only through the composite video output terminals, while the ones from the S-video input terminal are output only through the S-video output terminal.** Therefore, if your DVD player is connected to the receiver only through the S-video input terminal, you cannot record the picture from the DVD player on the VCR.

In addition, if the TV and the DVD player are connected to the receiver through the different video terminals, you cannot view the playback picture from the DVD player on the TV.

TV (as the monitor)

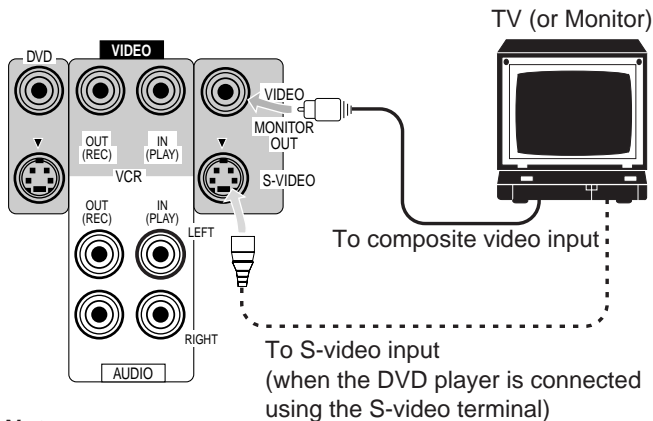

Note:

Use the video components of the PAL- or multi- color system.

VCR

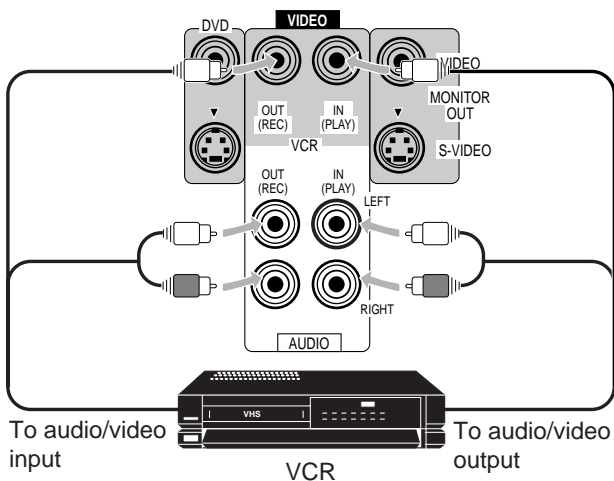

DVD player

- When you connect the DVD player with stereo output jacks:

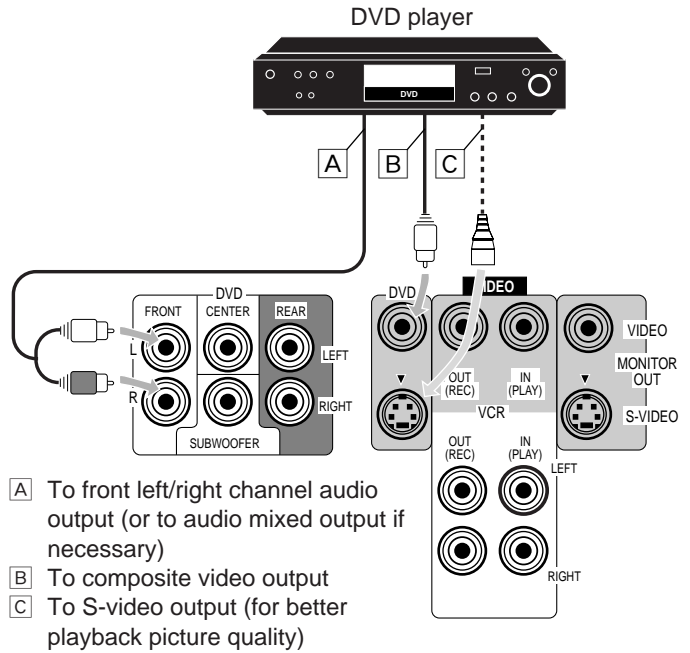

- When you connect the DVD player with its analog discrete output (5.1 CH reproduction) jacks:

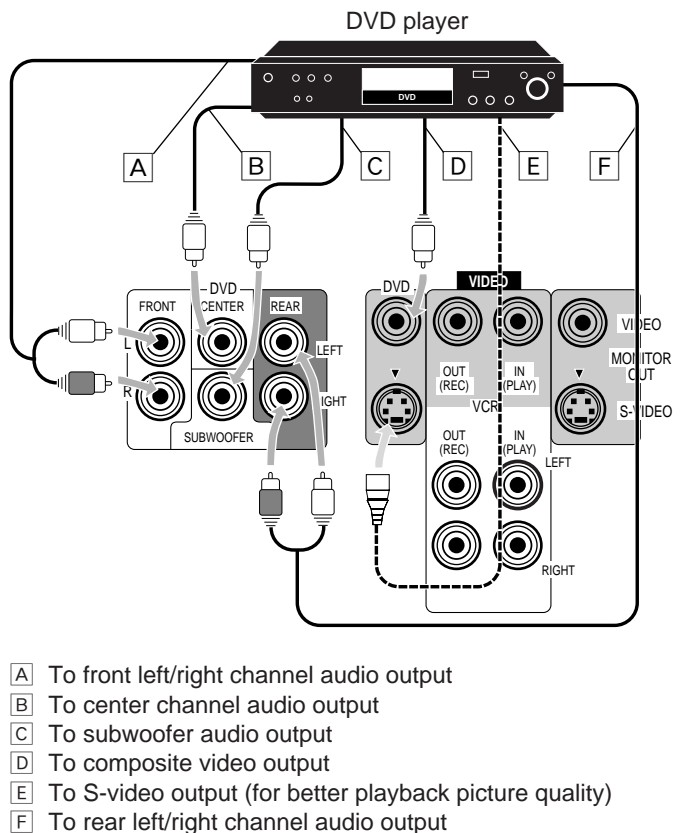

Connecting the Power Cord

Before plugging the receiver into an AC outlet, make sure that all connections have been made.

Plug the power cord into an AC outlet.

Keep the power cord away from the connecting cables and the antenna. The power cord may cause noise or screen interference. We recommend that you use a coaxial cable to connect the antenna, since it is well-shielded against interference.

Notes:

The preset settings such as preset channel and sound adjustment may be erased in a few days in the following cases:

- When you unplug the power cord.
- When a power failure occurs.

CAUTIONS:

- Do not touch the power cord with wet hands.
- Do not pull on the power cord to unplug the cord. When unplugging the cord, always grasp the plug so as not to damage the cord.

Putting Batteries in the Remote Control

Before using the remote control, put two supplied batteries first. When using the remote control, aim the remote control directly at the remote sensor on the receiver.

1. On the back of the remote control, remove the battery cover as illustrated.

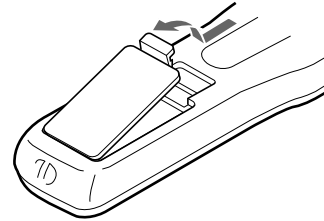

2. Insert batteries. Make sure to observe the proper polarity: (+) to (+) and (–) to (–).

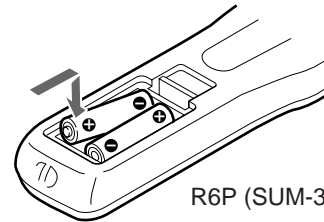

R6P (SUM-3)/AA (15F)

3. Replace the cover.

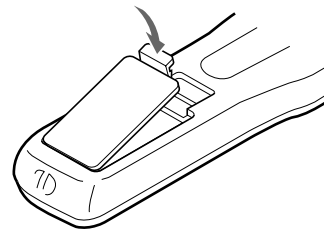

If the range or effectiveness of the remote control decreases, replace the batteries. Use two R6P (SUM-3)/AA (15F) type dry-cell batteries.

CAUTION:

Follow these precautions to avoid leaking or cracking cells:

- Place batteries in the remote control so they match the polarity indicated: (+) to (+) and (–) to (–).
- Use the correct type of batteries. Batteries that look similar may differ in voltage.
- Always replace both batteries at the same time.
- Do not expose batteries to heat or flame.

Basic Operations

The following operations are commonly used when you play any sound source.

Turning the Power On and Off (Standby)

On the front panel:

To turn on the power, press STANDBY/ON . The STANDBY lamp goes off. The name of the current source (or station frequency) appears on the display.

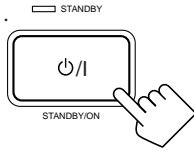

Current source name appears

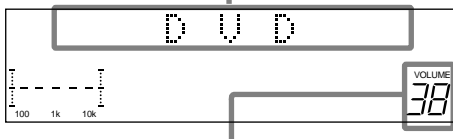

Current volume level is shown here

To turn off the power (into standby mode), press STANDBY/ON  again.

The STANDBY lamp lights up. A small amount of power is consumed in standby mode. To turn the power off completely, unplug the AC power cord.

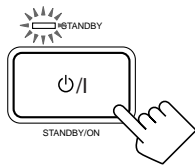

From the remote control:

To turn on the power, press AUDIO. The STANDBY lamp goes off. The name of the current source (or station frequency) appears on the display.



To turn off the power (into standby mode), press AUDIO again.

The STANDBY lamp lights up.

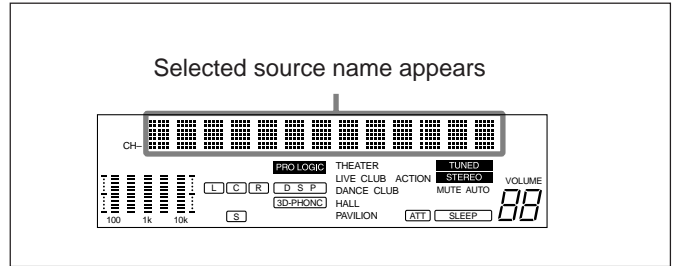

DVD MULTI Select the DVD player for viewing the digital video disc using the DVD analog discrete output mode (5.1CH reproduction) on the DVD player.

To enjoy the DVD MULTI playback, see page 20.

DVD Select the DVD player for viewing the stereo digital video disc.

VCR Select the video component connected to the VCR jacks.

TV SOUND Select the TV sound.

CD * Select the CD player.

PHONO * Select the turntable.

TAPE/MD * Select the cassette deck (or the MD recorder).

FM/AM * Select an FM or AM broadcast.

Each time you press the button, the band alternates between FM and AM.

Notes:

- When connecting an MD recorder (to the TAPE/MD jacks), change the source name that appears on the display. See page 11 for details.
- When you press one of the source selecting buttons on the remote control marked above with an asterisk (*), the receiver automatically turns on.

Selecting the Source to Play

Press one of the source selecting buttons.

On the front panel:

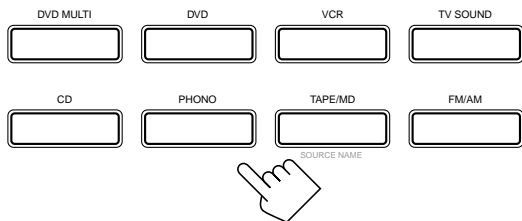

From the remote control:

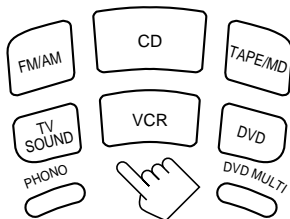

Selecting different sources for picture and sound

You can watch picture from a video component while listening to sound from another component.

Press one of the audio source selecting buttons (CD, TAPE/MD, PHONO, FM/AM, TV SOUND), while viewing the picture from a video component such as the VCR or DVD player, etc.

Note:

Once you have selected a video source, pictures of the selected source are sent to the TV until you select another video source.

Adjusting the Volume

On the front panel:

To increase the volume, turn MASTER VOLUME clockwise.

To decrease the volume, turn it counterclockwise.

- When you turn MASTER VOLUME rapidly, the volume level also changes rapidly.
- When you turn MASTER VOLUME slowly, the volume level also changes slowly.

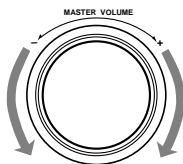

From the remote control:

To increase the volume, press VOLUME +.

To decrease the volume, press VOLUME -.



CAUTION:

Always set the volume to the minimum before starting any source. If the volume is set at its high level, the sudden blast of sound energy can permanently damage your hearing and/or ruin your speakers.

Note:

The volume level can be adjusted within the range of "0" (minimum) to "80" (maximum).

Selecting the Front Speakers

On the front panel ONLY:

When you have connected two pairs of the front speakers, you can select which to use. Pressing SPEAKERS 1 or SPEAKERS 2 activates the respective set of speakers.

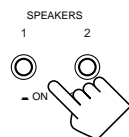

- To use the speakers connected to the FRONT SPEAKERS ① terminals, press SPEAKERS 1 to set it in the **ON** position, and press SPEAKERS 2 to set it in the **OFF** position.
- To use the speakers connected to the FRONT SPEAKERS ② terminals, press SPEAKERS 2 to set it in the **ON** position, and press SPEAKERS 1 to set it in the **OFF** position.
- To use both sets of the speakers, press SPEAKERS 1 to set it in the **ON** position, and press SPEAKERS 2 to set it in the **ON** position.
- To use neither set of the speakers, press SPEAKERS 1 and SPEAKERS 2 to set them in the **OFF** position.

Note:

When only one set of the speakers is connected to either the FRONT SPEAKERS ① or ② terminals, do not activate both pairs of the speakers. If you do, no sound comes out of the front speakers.

Listening only with headphones

1. Connect a pair of headphones to the PHONES jack on the front panel.
2. SPEAKERS 1 and SPEAKERS 2 to set them in the **OFF** position.

CAUTION:

Be sure to turn down the volume before connecting or putting on headphones, as high volume can damage both the headphones and your hearing.

Note:

You cannot shut off the sound through the other speakers using the SPEAKERS 1 and 2 buttons.

Muting the Sound

From the remote control ONLY:

Press MUTING to mute the sound through all speakers and headphones connected.

"MUTING" appears on the display and the volume turns off (the volume level indicator goes off).

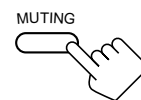

To restore the sound, press MUTING again so that "OFF" appears on the display.

- Turning MASTER VOLUME or pressing VOLUME +/- also restores the sound.

Recording a Source

You can record any source playing through the receiver to a cassette deck (or an MD recorder) connected to the TAPE/MD jacks and the VCR connected to the VCR jacks at the same time.

While recording, you can listen to the selected sound source at whatever sound level you like, without affecting the sound levels of the recording.

Note:

The output volume level, tone adjustment (see page 10), bass boost (see page 10) and DSP modes (see page 17) cannot affect the recording.

IMPORTANT:

Before recording, turn off the DVD MULTI playback mode.

Attenuating the Input Signal

When the input level of the playing source is too high, the sounds will be distorted. If this happens, you need to attenuate the input signal level to prevent the sound distortion.

On the front panel ONLY:

Press INPUT ATT. so that the lamp next to the button lights up.

The ATT indicator also lights up on the display.

- Each time you press the button, the Input Attenuator mode turns on (“INPUT ATT ON”) or off (“INPUT NORMAL”).

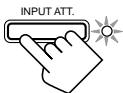

Note:

When selecting “DVD MULTI” as the source, this effect only applies to front left and right channel signals.

Adjusting the Front Speaker Output Balance

If the sounds you hear from the front right and left speakers are unequal, you can adjust the speaker output balance.

Before you start, remember...

- There is a time limit in doing the following steps. If the setting is canceled before you finish, start from step 1 again.

On the front panel ONLY:

1. Press ADJUST so that the cursor control Δ / ∇ buttons work for adjusting the sound.

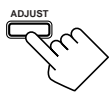

2. Press cursor control Δ / ∇ repeatedly until “L/R BALANCE” appears on the display.

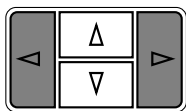

3. Press cursor control \triangleleft / \triangleright to adjust the balance.

- Pressing \triangleleft decreases the right channel output (from “L-21” to “R-21”).
- Pressing \triangleright decreases the left channel output (from “R-21” to “L-21”).

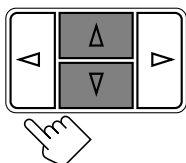

Reinforcing the Bass

With this Bass Boost function, you can boost the bass level.

Before you start, remember...

- There is a time limit in doing the following steps. If the setting is canceled before you finish, start from step 1 again.

On the front panel ONLY:

1. Press ADJUST so that the cursor control Δ / ∇ buttons work for adjusting the sound.



2. Press cursor control Δ / ∇ repeatedly until “BASSBOOST” (with the current setting) appears on the display.

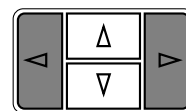

3. Press cursor control \triangleleft / \triangleright to switch this function “ON” or “OFF.”

- When this function is switched “ON,” the BASS BOOST lamp on the front panel lights up.

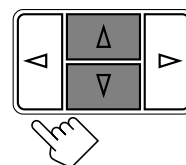

Note:

The Bass Boost function affects the front speaker sounds only.

Adjusting the Tone

You can adjust the treble and bass sounds as you like.

Before you start, remember...

- There is a time limit in doing the following steps. If the setting is canceled before you finish, start from step 1 again.

On the front panel ONLY:

1. Press ADJUST so that the cursor control Δ / ∇ buttons work for adjusting the sound.

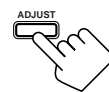

2. Press cursor control Δ / ∇ repeatedly until “BASS” or “TREBLE” appears on the display.

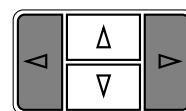

- Select “BASS” to adjust the bass sound level.
- Select “TREBLE” to adjust the treble sound level.

3. Press cursor control \triangleleft / \triangleright to adjust the bass or treble sound level within the range of -10 to $+10$.

- Each time you press the button, the sound level changes by ± 2 steps.

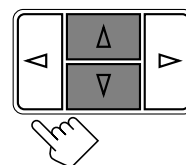

Basic Settings

Some of the following settings are required after connecting and positioning your speakers in your listening room, while others will make operations easier.

Changing the Source Name

When you have connected an MD recorder to the TAPE/MD jacks on the rear panel: Change the source name shown on the display when you select the MD recorder as the source.

On the front panel ONLY:

When changing the source name from "TAPE" to "MD":

1. Press TAPE/MD.

- Make sure "TAPE" appears on the display.

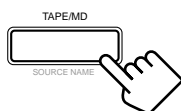

2. Press and hold SOURCE NAME (the same button as TAPE/MD) until "ASSGN. MD" appears on the display.

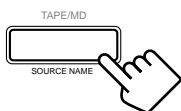

To change the source name from "MD" to "TAPE," repeat the same procedure above (in step 1, make sure "MD" appears on the display).

Note:

Without changing the source name, you can still use the connected components. However, there may be some inconvenience.

- "TAPE" will appear on the display when you select the MD recorder.
- You cannot use the COMPU LINK remote control system (see page 25) to operate the MD recorder.

Setting Center and Rear Speakers for the DSP Modes

To obtain the best possible surround sound of the DSP (Digital Signal Processor) modes (see page 17), you have to register the information about the speakers arrangement after all connections are completed.

Center Speaker Setting

Register the center speaker size.

Before you start, remember...

- There is a time limit in doing the following steps. If the setting is canceled before you finish, start from step 1 again.

On the front panel ONLY:

1. Press SETTING so that the cursor control Δ / ∇ buttons work for setting the center speaker size.

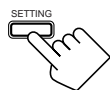

2. Press cursor control Δ / ∇ repeatedly until "CENTER SPK" (Center Speaker) appears on the display.

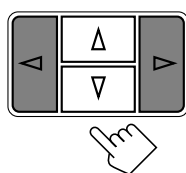

3. Press cursor control \triangleleft / \triangleright to select your center speaker size.

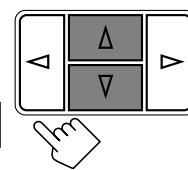
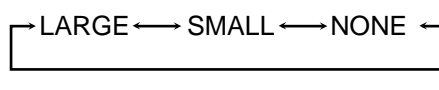

LARGE: Select this mode when the size of the center speaker is the same as that of the front speakers.

SMALL: Select this mode when the size of the center speaker is smaller than that of the front speakers.

NONE: Select this mode when you do not use a center speaker.

Rear Speaker Setting

Register whether you have connected the rear speakers or not.

Before you start, remember...

- There is a time limit in doing the following steps. If the setting is canceled before you finish, start from step 1 again.

On the front panel ONLY:

1. Press SETTING so that the cursor control Δ / ∇ buttons work for setting the rear speaker information.

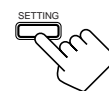

2. Press cursor control Δ / ∇ repeatedly until "REAR SPK" (Rear Speaker) appears on the display.

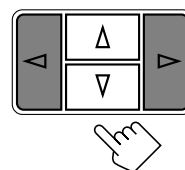

3. Press cursor control \triangleleft / \triangleright to register whether you have connected the rear speakers.

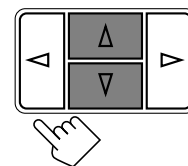

YES: Select this mode when you use rear speakers.

NO: Select this mode when you do not use rear speakers.

Note:

When you change your speakers, you need to register the information about the speakers again.

Delay Time Setting

Register the delay time of the sound from the rear speakers, comparing the sound from the front speakers. Delay time is only valid for "PRO LOGIC." (See page 15.)

Before you start, remember...

- There is a time limit in doing the following steps. If the setting is canceled before you finish, start from step 1 again.
- You can adjust the delay time only when you have connected the rear speakers and have set "REAR SPK" to "YES" (See above).

On the front panel:

1. Press **SETTING** so that the cursor control Δ / ∇ buttons work for setting the delay time.

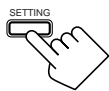

2. Press cursor control Δ / ∇ repeatedly until “**DELAY TIME**” appears on the display.

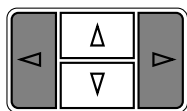

3. Press cursor control $\triangleleft / \triangleright$ to select an appropriate delay time.

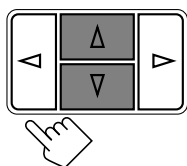

DELAY 15msec \longleftrightarrow DELAY 20msec \longleftrightarrow DELAY 30msec

As the distance from you to your rear speakers decreases, you will get the better surround sound by using the smaller delay time.

From the remote control:

1. Press **SOUND CONTROL**.
2. Press **SURROUND** repeatedly until “**PRO LOGIC**” appears on the display.
3. Press **DELAY** repeatedly until an appropriate delay time appears on the display.

Using the Sleep Timer

Using the Sleep Timer, you can fall asleep to music and know the receiver will turn off by itself rather than play all night.

From the remote control ONLY:

Press **SLEEP** repeatedly.

The **SLEEP** indicator lights up on the display, and the shut-off time changes as follows (in minutes):

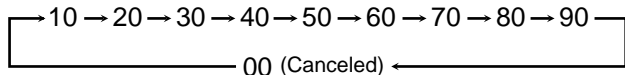
**When the shut-off time comes**

The receiver turns off automatically.

To check or change the time remaining until the shut-off time

Press **SLEEP** once.

The remaining time until the shut-off time appears in minutes.

- To change the shut-off time, press **SLEEP** repeatedly.

To cancel the Sleep Timer

Press **SLEEP** repeatedly until “**SLEEP 00min.**” appears on the display. (The **SLEEP** indicator goes off.)

Turning off the power also cancels the Sleep Timer.

Storing the Basic Settings and Adjustments — One Touch Operation

JVC's One Touch Operation function is used to assign and store different sound settings for each different playing source. By using this function, you don't have to change the settings every time you change the source. The stored settings for the newly selected source are automatically recalled.

The following can be stored for each source:

- Volume level (see page 9)
- Input Attenuator (see page 10)
- Balance (see page 10)
- Bass Boost (see page 10)
- Tone adjustment (see page 10)
- DSP modes
 - 3D-PHONIC mode settings (see page 17)
 - DAP mode settings (see page 17)
 - Surround mode settings (see page 18)
- DVD MULTI playback mode settings (see page 20)

To store the sound settings

1. Press **ONE TOUCH OPERATION**.

The **ONE TOUCH OPERATION** lamp lights up, then the previously memorized settings are recalled.



On the front panel



On the remote

2. Adjust the sound using the functions listed above.

The newly adjusted settings are memorized.

To recall the sound settings

With the **ONE TOUCH OPERATION** lamp lit, the settings for the currently selected source are recalled, when the source is selected.

To cancel the One Touch Operation function

Press **ONE TOUCH OPERATION** so that the lamp goes off. (Even though the One Touch Operation function is canceled, the recalled sound effects remain active.)

Notes:

- If the source is **FM** or **AM**, you can assign a different setting for each band.
- The **DSP modes** and **DVD MULTI playback mode** cannot be used at the same time.

Receiving Radio Broadcasts

You can browse through all the stations or use the preset function to go immediately to a particular station.

Setting the AM Tuner Interval Spacing

Some countries space AM stations 9 kHz apart, and other countries use 10 kHz spacing. When shipped, the spacing is set to 9 kHz.

On the front panel ONLY:

To select the 10 kHz interval:

Be sure the receiver is tuned off, but is plugged into an AC outlet. Hold down cursor control Δ and press STANDBY/ON $\cup/|$. Now the 10 kHz interval is selected.

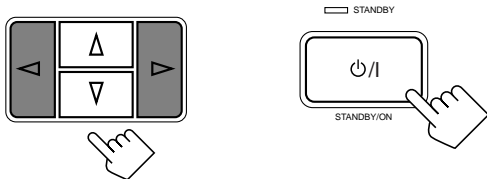

To change back to the 9 kHz interval:

Be sure the receiver is tuned off, but plugged into an AC outlet. Hold down cursor control ∇ and press STANDBY/ON $\cup/|$. Now the 9 kHz interval is selected.

Tuning in Stations Manually

On the front panel ONLY:

1. Press FM/AM to select the band.

The cursor control Δ / ∇ / \triangleleft / \triangleright buttons can be now used for operating the tuner.

- Each time you press the button, the band alternates between FM and AM.

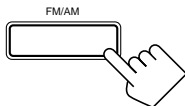

2. Press cursor control Δ / ∇ repeatedly until “- TUNING +” appears on the display.

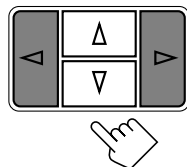

3. Press cursor control \triangleleft / \triangleright until you find the frequency you want.

- Pressing \triangleleft decreases the frequency.
- Pressing \triangleright increases the frequency.

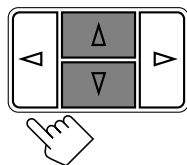

Notes:

- When you hold cursor control \triangleleft / \triangleright in step 3, the frequency keeps changing until a station is tuned in.
- When a station of sufficient signal strength is tuned in, the TUNED indicator lights up on the display. When an FM stereo program is received, the STEREO indicator also lights up.

Using Preset Tuning

Once a station is assigned to a channel number, the station can be quickly tuned. You can preset up to 30 FM and 15 AM stations.

To store the preset stations

Before you start, remember...

- There is a time limit in doing the following steps. If the setting is canceled before you finish, start from step 1 again.

On the front panel ONLY:

1. Tune in the station you want to preset (see left).

If you want to store the FM reception mode for this station, select the FM reception mode you want. See “Selecting the FM Reception Mode.”

2. Press MEMORY.

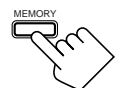
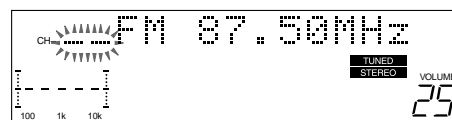

“CH-” appears and the channel number position starts flashing on the display for about 5 seconds.

3. Press cursor control \triangleleft / \triangleright to select a channel number while the channel number position is flashing.

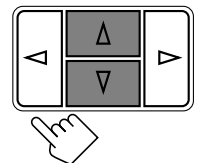

Note:

You can use the 10 keys on the remote control to select the preset number. When using the 10 keys, be sure that they are activated for the tuner, not for the CD and others. (See page 31.)

4. Press MEMORY again while the selected channel number is flashing.

The selected channel number stops flashing.

The station is assigned to the selected channel number.

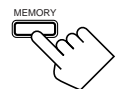

To store other stations into other channel numbers

Once you have preset a station, the cursor control \triangleleft / \triangleright buttons work for selecting preset channels. To tuner in another station to preset, press cursor control Δ / ∇ repeatedly until “- TUNING +” appears on the display, then repeat steps 1 to 4 above.

To erase a stored preset station

Storing a new station on a used number erases the previously stored one.

To tune in a preset station

On the front panel:

1. Press FM/AM to select the band.

The cursor control Δ / ∇ / \triangleleft / \triangleright buttons can be now used for operating the tuner.

- Each time you press the button, the band alternates between FM and AM.

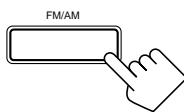

2. Press cursor control Δ / ∇ repeatedly until “ – PRESET +” appears on the display.

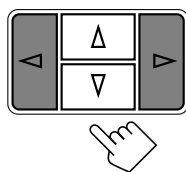

3. Press cursor control \triangleleft / \triangleright to select a preset channel station.

- Pressing \triangleleft decreases the preset channel number.
- Pressing \triangleright increases the preset channel number.

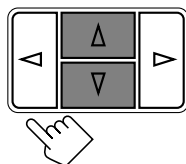

From the remote control:

1. Press FM/AM.

- Each time you press the button, the band alternates between FM and AM.



2. Press 10 keys to select a preset channel number.

- For channel number 5, press 5.
- For channel number 15, press +10 then 5.
- For channel number 20, press +10 then 10.
- For channel number 30, press +10, +10, then 10.

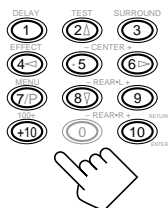

Note:

When you use the 10 keys on the remote control, be sure that they are activated for the tuner, not for the CD and others. (See page 31.)

Selecting the FM Reception Mode

When an FM stereo broadcast is hard to receive or noisy

You can change the FM reception mode while receiving an FM broadcast.

On the front panel ONLY:

1. Press FM/AM to select the band.

The cursor control Δ / ∇ / \triangleleft / \triangleright buttons can be now used for operating the tuner.

- Each time you press the button, the band alternates between FM and AM.

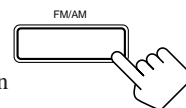

2. Press cursor control Δ / ∇ repeatedly until “FM MODE” appears on the display.

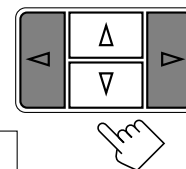

3. Press cursor control \triangleleft / \triangleright to switch the FM reception “AUTO” or “MONO.”

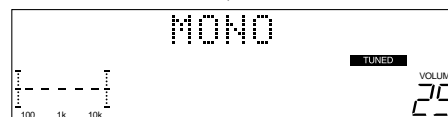
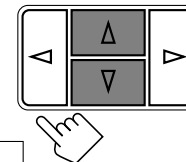
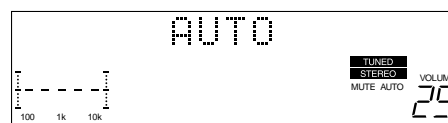

AUTO: When a program is broadcasted in stereo, you will hear stereo sound; when in monaural, you will hear monaural sounds. This mode is also useful to suppress static noise between stations. The MUTE AUTO indicator lights up on the display.

MONO: Reception will be improved although you will lose the stereo effect. In this mode, you will hear noise while tuning into the stations. The MUTE AUTO indicator goes off on the display.

Using the DSP Modes

The built-in Surround Processor provides three types of the DSP (Digital Signal Processor) mode — 3D-PHONIC mode, DAP (Digital Acoustic Processor) mode and Surround mode (Dolby Pro Logic and JVC Theater Surround.)

3D-PHONIC modes

The 3D-PHONIC mode gives you such a nearly surround effect as it is reproduced through the Dolby Surround decoder, which is widely used to reproduce sounds with a feeling of movement like those experienced in movie theaters. The 3D-PHONIC mode is the result of research on sound localization technology carried out at JVC for many years. **This mode is selected when two front speakers are connected to this receiver (without respect to the rear/center speaker connection).**

You can select either 3D ACTION or 3D THEATER to your preference.

3D ACTION: Best for action and war movies — where the action is fast and explosive.

3D THEATER: Reproduces the sound field of a large theater.

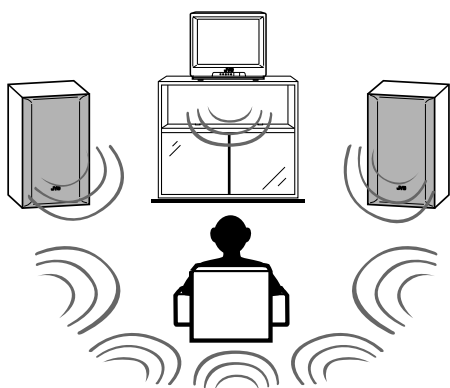

DAP modes

The sound heard in a concert hall or club consists of direct sound and indirect sound — early reflections and reflections from behind. Direct sounds reach the listener directly without any reflection. On the other hand, indirect sounds are delayed by the distances of the ceiling and walls. These direct sounds and indirect sounds are the most important elements of the acoustic surround effects. The DAP mode can create these important elements, and gives you a real “being there” feeling. **This mode can be used when the front speakers are connected to this receiver (without respect to the rear/center speaker connection).**

You can select one of the following to your preference.

LIVE CLUB: Gives the feeling of a live music club with a low ceiling.

DANCE CLUB: Gives a throbbing bass beat.

HALL: Gives clear vocal and the feeling of a concert hall.

PAVILION: Gives the spacious feeling of a pavilion with a high ceiling.

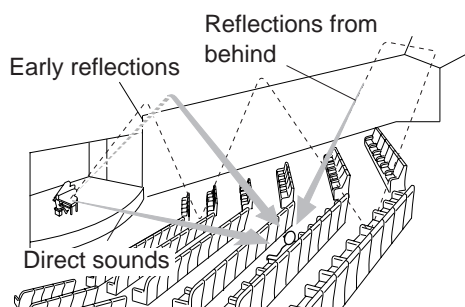

Surround Modes

With this receiver, you can use two types of the Surround modes.

• Dolby Surround

Dolby Surround has been developed to reproduce the important elements of the acoustic surround at home.

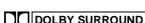
To watch the soundtracks of video software bearing the mark  * which includes the same encoded surround information as found in Dolby Stereo films, the receiver can provide you with Dolby Surround decoder.

There are two types of Dolby Surround — “Pro Logic” and “3 Stereo.”

“Pro Logic” can be used when the front speakers and rear speakers are connected to this receiver (regardless of the center speaker connection). On the other hand, “3 Stereo” can be used when the rear speakers are not connected (center speaker must be connected).

• JVC Theater Surround

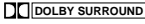
In order to reproduce a more realistic sound field in your listening room while playing soundtracks of video software bearing the mark , JVC Theater Surround has been designed to give you clearer vocals and to create a real “being there” feeling.

This mode can be used when the front speakers and rear speakers are connected to this receiver (without respect to the center speaker connection).

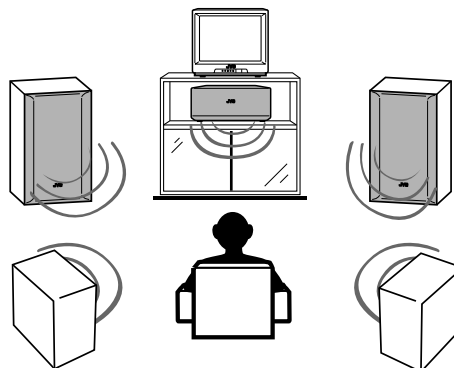

Notes:

- The DSP modes have no effect on monaural sources.
- The DSP modes cannot be used for recording.
- When you select “DVD MULTI” as the source to play, you cannot select or adjust the DSP modes.

IMPORTANT:

Before recording, turn off the DVD MULTI playback mode.

As for the DVD MULTI playback mode, see page 20.

* Manufactured under license from Dolby Laboratories Licensing Corporation. “Dolby,” the double-D symbol, and “Pro Logic” are trademarks of Dolby Laboratories Licensing Corporation.

Available DSP Modes According to the Speaker Arrangement

Available DSP modes will vary depending on how many speakers are used with this receiver.
Make sure that you have set the speaker information correctly (see page 11).

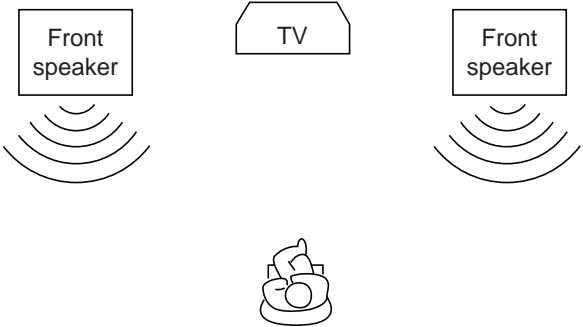
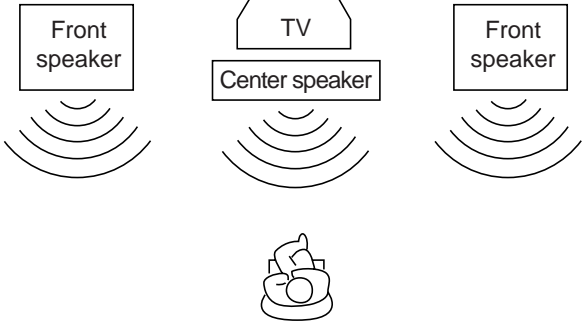
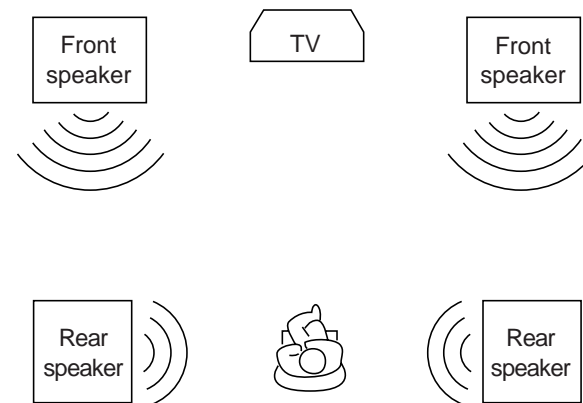
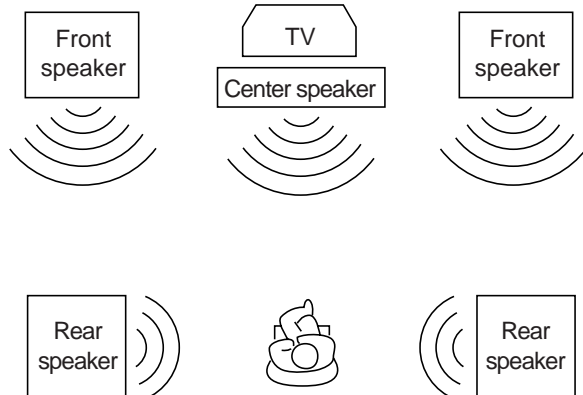
Speaker arrangements	Available DSP modes
 <p>Diagram showing two front speakers, a TV, and a subwoofer.</p>	<p>Each time you press SURROUND, the DSP modes change as follows:</p> <ul style="list-style-type: none"> • 3D THEATER • LIVE CLUB • DANCE CLUB • HALL • PAVILION • 3D ACTION • OFF (DSP mode is canceled)
 <p>Diagram showing two front speakers, a TV, a center speaker, and a subwoofer.</p>	<p>Each time you press SURROUND, the DSP modes change as follows:</p> <ul style="list-style-type: none"> • DOLBY (3 Stereo)* • 3D THEATER • LIVE CLUB • DANCE CLUB • HALL • PAVILION • 3D ACTION • OFF (DSP mode is canceled) <div style="border: 1px solid black; padding: 5px; width: fit-content;"> <p>* Though "3 Stereo" is selected, "PRO LOGIC" appears on the display.</p> </div>
 <p>Diagram showing two front speakers, a TV, and two rear speakers.</p>	<p>Each time you press SURROUND, the DSP modes change as follows:</p> <ul style="list-style-type: none"> • DOLBY (PRO LOGIC) • THEATER • LIVE CLUB • DANCE CLUB • HALL • PAVILION • 3D ACTION • OFF (DSP mode is canceled)
 <p>Diagram showing two front speakers, a TV, a center speaker, and two rear speakers.</p>	<p>Each time you press SURROUND, the DSP modes change as follows:</p> <ul style="list-style-type: none"> • DOLBY (PRO LOGIC) • THEATER • LIVE CLUB • DANCE CLUB • HALL • PAVILION • 3D ACTION • OFF (DSP mode is canceled)

Adjusting the 3D-PHONIC Modes

Before you start, remember...

- Make sure that you have set the speaker information correctly (see page 11).
- There is a time limit in doing the following steps. If the setting is canceled before you finish, start from step 1 again.

On the front panel:

1. Press SURROUND repeatedly until “3D ACTION” or “3D THEATER,” appears on the display.

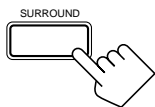

The 3D-PHONIC, DSP, PRO LOGIC and the selected 3D-PHONIC mode indicators also light up on the display.

2. Press ADJUST so that the cursor control Δ / ∇ / \triangleleft / \triangleright buttons work for adjusting the surround setting.

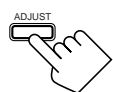

3. Press cursor control Δ / ∇ repeatedly until “DSP EFFECT” appears on the display.

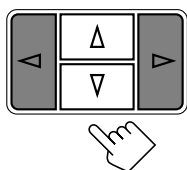

4. Press cursor control \triangleleft / \triangleright to select an effect level you want.

- Each time you press the button, the effect level changes as follows:

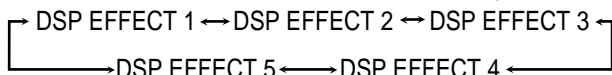
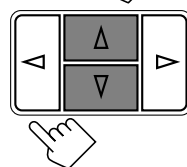

As the number increases, the selected 3D-PHONIC mode becomes stronger.

From the remote control:

1. Press SOUND CONTROL.

The 10 keys are activated for sound adjustments.



2. Press SURROUND repeatedly until “3D ACTION” or “3D THEATER,” appears on the display.

The 3D-PHONIC, DSP, PRO LOGIC and the selected 3D-PHONIC mode indicators also light up on the display.



3. Press EFFECT to select an effect level you want.

- Each time you press the button, the effect level changes as follows:

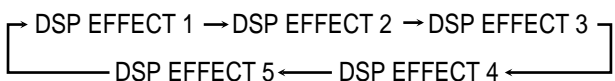

As the number increases, the selected 3D-PHONIC mode becomes stronger.

Adjusting DAP (Digital Acoustic Processor) Modes

Before you start, remember...

- Make sure that you have set the speaker information correctly (see page 11).
- There is a time limit in doing the following steps. If the setting is canceled before you finish, start from step 1 again.
- You can only adjust the rear speaker output level when you have connected the rear speakers and have set “REAR SPK” to “YES.” See page 11.

On the front panel:

1. Press SURROUND repeatedly until the DAP mode — LIVE CLUB, DANCE CLUB, HALL, or PAVILION — appears on the display.

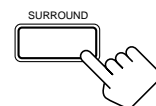

The DSP and the selected DAP mode indicators also light up on the display.

2. Press ADJUST so that the cursor control Δ / ∇ / \triangleleft / \triangleright buttons work for adjusting the DSP setting.



3. Press cursor control Δ / ∇ repeatedly until “REAR LEVEL” appears on the display.

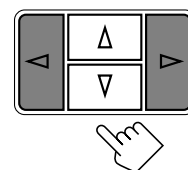

4. Press cursor control \triangleleft / \triangleright to adjust the rear speaker output level (from -10 to +10).

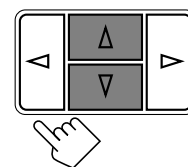

Note:

You cannot adjust the left and right rear speaker output levels separately.

5. Press cursor control Δ / ∇ repeatedly until “DSP EFFECT” appears on the display.

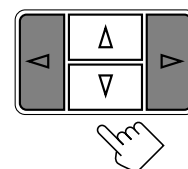

6. Press cursor control \triangleleft / \triangleright to select an effect level you want.

- Each time you press the button, the effect level changes as follows:

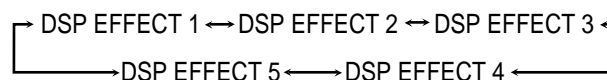
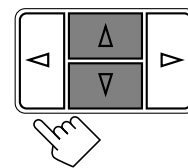

As the number increases, the selected DAP mode becomes stronger.

From the remote control:**1. Press SOUND CONTROL.**

The 10 keys are activated for sound adjustments.

**2. Press SURROUND repeatedly until the DAP mode — LIVE CLUB, DANCE CLUB, HALL, or PAVILION — appears on the display.**

The DSP and the selected DAP mode indicators also light up on the display.

**3. Press REAR•L - / + to adjust the rear speaker output level.**

- Pressing REAR•L - decreases the output level up to -10 dB.
- Pressing REAR•L + increases the output level up to +10 dB.

**Note:**

You cannot adjust the left and right rear speaker output levels separately.

4. Press EFFECT to select an effect level you want.

- Each time you press the button, the effect level changes as follows:

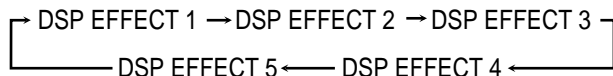

As the number increases, the selected DAP mode becomes stronger.



Adjusting the Surround Modes — Dolby Surround and JVC Theater Surround

Before you start, remember...

- Make sure that you have set the speaker information correctly (see page 11).
- There is a time limit in doing the following steps. If the setting is canceled before you finish, start from step 1 again.
- You can only adjust the effect level when selecting JVC Theater Surround.
- You can only adjust the rear and/or center speaker output levels when you have connected rear speakers and/or a center speaker and have set “REAR SPK” and/or “CENTER SPK” correctly. See page 11.

From the remote control:**1. Press SOUND CONTROL.**

The 10 keys are activated for sound adjustments.

**2. Press SURROUND repeatedly until the mode — “PRO LOGIC” or “THEATER” — appears on the display.**

- When selecting “PRO LOGIC,” the PRO LOGIC indicator also lights up on the display.
- When selecting “THEATER,” the DSP, PRO LOGIC and THEATER indicators also light up on the display.

**3. Press TEST to check the speaker output balance.**

“TEST TONE L” starts flashing on the display, and a test tone comes out of the speakers in the following order:

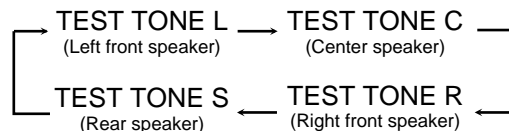
**Notes:**

- You can adjust the speaker output levels without outputting the test tone.
- The speaker indicators also light on the display while the test tone comes out of the speakers.

L: Lights when the test tone comes out of the left front speaker.

C: Lights when the test tone comes out of the center speaker.

R: Lights when the test tone comes out of the right front speaker.

S: Lights when the test tone comes out of the rear speakers.

L C R

S

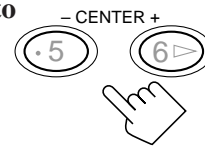
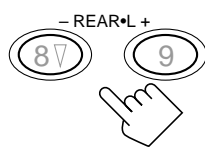
4. Press CENTER - / + repeatedly to adjust the center speaker output level (from -10 to +10).**5. Press REAR•L - / + to adjust the rear speaker output level (from -10 to +10).****Notes:**

- You cannot adjust the left and right rear speaker output levels separately.
- You cannot use the REAR•R -/+ buttons to adjust the speaker output levels.

6. Press TEST again to stop the test tone.**7. ONLY FOR “THEATER”:****Press EFFECT to select an effect level you want.**

- Each time you press the button, the effect level changes as follows:

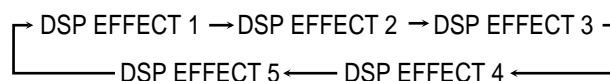

As the number increases, JVC Theater Surround becomes stronger.



On the front panel:

You can also use the buttons on the front panel to adjust the Surround modes. However, no test tone is available when using the buttons on the front panel. So, make adjustments while listening to the sound of the source played back.

1. Press SURROUND repeatedly until the mode — “PRO LOGIC” or “THEATER” — appears on the display.

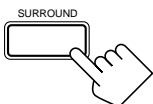

- When selecting “PRO LOGIC,” the PRO LOGIC indicator also lights up on the display.
- When selecting “THEATER,” the DSP, PRO LOGIC and THEATER indicators also light up on the display.

2. Press ADJUST so that the cursor control $\Delta / \nabla / \triangleleft / \triangleright$ buttons work for adjusting the DSP setting.

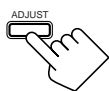

3. Press cursor control Δ / ∇ repeatedly until “CENTER LEVEL” appears on the display.

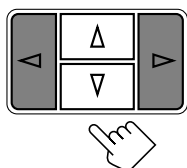

4. Press cursor control $\triangleleft / \triangleright$ to adjust the center speaker output level (from -10 to +10).

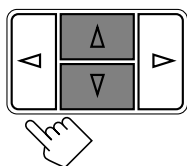

5. Press cursor control Δ / ∇ repeatedly until “REAR LEVEL” appears on the display.

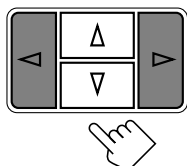

6. Press cursor control $\triangleleft / \triangleright$ to adjust the rear speaker output level (from -10 to +10).

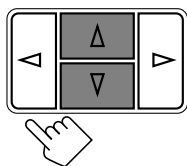
**Note:**

You cannot adjust the left and right rear speaker output levels separately.

7. ONLY FOR “THEATER”:

Press cursor control Δ / ∇ repeatedly until “DSP EFFECT” appears on the display.

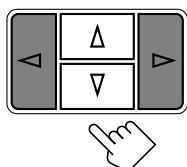
**8. ONLY FOR “THEATER”:**

Press cursor control $\triangleleft / \triangleright$ to select an effect level you want.

- Each time you press the button, the effect level changes as follows:

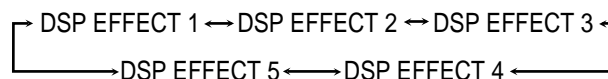
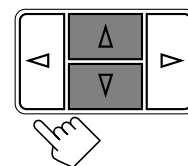

As the number increases, JVC Theater Surround becomes stronger.

Activating the DSP Modes

Once you have finished adjustments for the DSP modes, you can use the same adjustments every time you want to use these modes.

On the front panel:

1. Press SURROUND repeatedly until the DSP mode you want appears on the display.

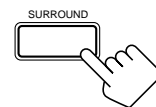

- Each time you press the button, the DSP modes change. (See page 18 for more details.)

2. Select and play a sound source.

- To enjoy the 3D-PHONIC, Dolby Surround, and JVC Theater Surround, play back a software which was processed with Dolby Surround and is labeled with mark.

To cancel the DSP mode

Press SURROUND repeatedly until “OFF” appears on the display.

From the remote control:

1. Press SOUND CONTROL.

The 10 keys are activated for sound adjustments.

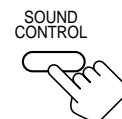

2. Press SURROUND repeatedly until the DSP mode you want appears on the display.

- Each time you press the button, the DSP modes change. (See page 18 for more details.)



3. Select and play a sound source.

- To enjoy the 3D-PHONIC, Dolby Surround, and JVC Theater Surround, play back a software which was processed with Dolby Surround and is labeled with mark.

To cancel the DSP mode

Press SURROUND repeatedly until “OFF” appears on the display in step 2 above.

Using the DVD MULTI Playback Mode

This receiver provides the DVD MULTI playback mode for reproducing the analog discrete output mode of the DVD player. Before playing back a DVD, refer also to the manual supplied with the DVD player.

Activating the DVD MULTI Playback Mode

You can adjust the DVD MULTI playback mode while playing back a DVD using the analog discrete output mode on the DVD player. Once you made adjustments, the receiver memorizes the adjustments until you change them. You also need to set the DVD player to the analog discrete output mode.

Before you start, remember...

- Make sure that you have set the speaker information correctly (see page 11).
- There is a time limit in doing the following steps. If the setting is canceled before you finish, start from step 1 again.
- You can only adjust the rear and/or center speaker output levels when you have connected rear speakers and/or a center speaker and have set "REAR SPK" and/or "CENTER SPK" correctly. See page 11.

On the front panel:

1. Press DVD MULTI so that "DVD MULTI" appears on the display.



Note:

When you select "DVD MULTI" as the source to play, the DSP mode is canceled temporarily, and the SURROUND button does not work.

2. Select the analog discrete output mode on the DVD player, and start playing a DVD.

- Refer to the manual supplied with the DVD player.

If you need to make any adjustment, go to the following steps.

3. Press ADJUST so that the cursor control $\Delta / \nabla / \triangleleft / \triangleright$ buttons work for adjusting the DVD MULTI playback setting.

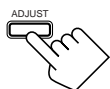

4. Press cursor control Δ / ∇ repeatedly until "CENTER LEVEL" appears on the display.

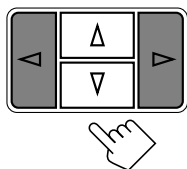

5. Press cursor control $\triangleleft / \triangleright$ to adjust the center speaker output level (from -10 to +10).

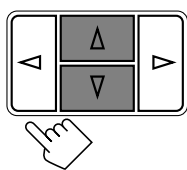

6. Press cursor control Δ / ∇ repeatedly until "REAR L LEVEL" appears on the display.

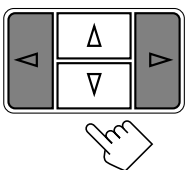

7. Press cursor control $\triangleleft / \triangleright$ to adjust the left rear speaker output level (from -10 to +10).

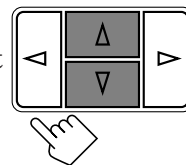

8. Press cursor control Δ / ∇ repeatedly until "REAR R LEVEL" appears on the display.

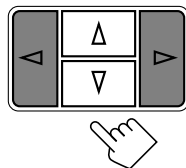

9. Press cursor control $\triangleleft / \triangleright$ to adjust the right rear speaker output level (from -10 to +10).

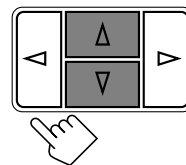

From the remote control:

1. Press DVD MULTI so that "DVD MULTI" appears on the display.



Note:

When you select "DVD MULTI" as the source to play, the DSP mode is canceled temporarily, and the SURROUND button does not work.

2. Select the analog discrete output mode on the DVD player, and start playing a DVD.

- Refer to the manual supplied with the DVD player.

If you need to make any adjustment, go to the following steps.

3. Press SOUND CONTROL. 10 keys are activated for adjusting the sound.



4. Press CENTER - / + to adjust the center speaker output level.

- Pressing CENTER - decreases the output level up to -10 dB.
- Pressing CENTER + increases the output level up to +10 dB.

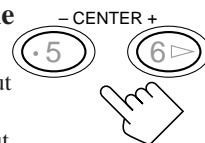

5. Press REAR•L - / + to adjust the left rear speaker output level.

- Pressing REAR•L - decreases the output level up to -10 dB.
- Pressing REAR•L + increases the output level up to +10 dB.

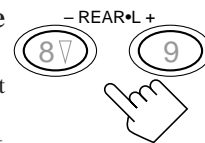

6. Press REAR•R - / + to adjust the right rear speaker output level.

- Pressing REAR•R - decreases the output level up to -10 dB.
- Pressing REAR•R + increases the output level up to +10 dB.

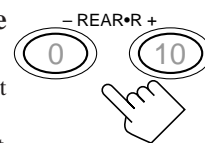

Using the On-Screen Menus

You can use the Menus on the TV screen to control the receiver.

To use this function, you need to connect the TV to the MONITOR OUT jack on the rear panel (see page 6), and set the TV's input mode to the proper position to which the receiver is connected.

- When the TV's input mode is incorrect; for example, a different video input or TV tuner mode is selected, you cannot show the Menus on the TV screen.

On-Screen Operation buttons (on the remote control)

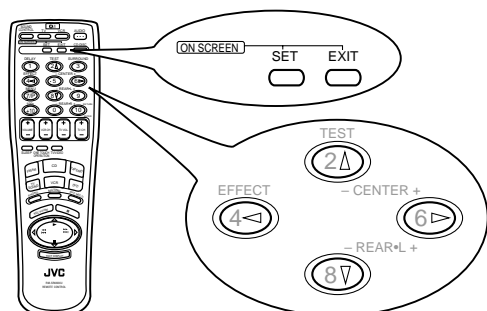

Selecting the Source to Play (Also see page 8)

1. Press ON SCREEN SET.
2, 8, 4, and 6 buttons on the 10 keys work as Δ / ∇ / \triangleleft / \triangleright for ON SCREEN operations.
2. Press any one of Δ / ∇ / \triangleleft / \triangleright .
The MAIN MENU appears on the TV.

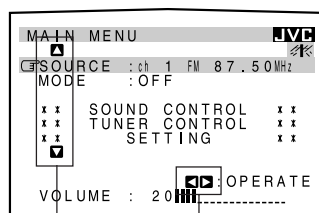

Shows the buttons you can use on the current menu.
In this case, use Δ / ∇ to move \square up and down, and \triangleleft / \triangleright to select, adjust or set the item.

Notes:

- If your TV is not of the PAL color system, the TV screen will be distorted.
- The on-screen display will disappear if no operation is done for about 1 minute.

3. Press Δ / ∇ to move \square to "SOURCE."
4. Press \triangleleft / \triangleright to select the source.
5. When you finish, press ON SCREEN EXIT.
The menu disappears from the TV.

Activating the DSP Modes (Also see page 19)

1. Press ON SCREEN SET.
2, 8, 4, and 6 buttons on the 10 keys work as Δ / ∇ / \triangleleft / \triangleright for ON SCREEN operations.
2. Press any one of Δ / ∇ / \triangleleft / \triangleright .
The MAIN MENU appears on the TV.
3. Press Δ / ∇ to move \square to "MODE."
4. Press \triangleleft / \triangleright to select the DSP mode you want to use.
5. When you finish, press ON SCREEN EXIT.
The menu disappears from the TV.

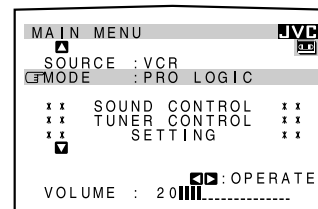

Adjusting the Front Speaker Output Balance (Also see page 10)

1. Press ON SCREEN SET.
2, 8, 4, and 6 buttons on the 10 keys work as Δ / ∇ / \triangleleft / \triangleright for ON SCREEN operations.
2. Press any one of Δ / ∇ / \triangleleft / \triangleright .
The MAIN MENU appears on the TV.
3. Press Δ / ∇ to move \square to "SOUND CONTROL," then press \triangleleft / \triangleright .
The SOUND CONTROL menu appears.
4. Press Δ / ∇ to move \square to "BAL." (Balance).
5. Press \triangleleft / \triangleright to adjust the balance.
6. When you finish, press ON SCREEN EXIT repeatedly until the menu disappears from the TV.

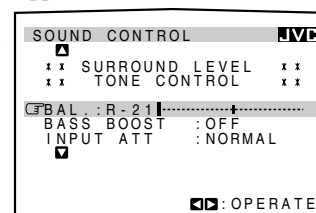

Reinforcing the Bass (Also see page 10)

1. Press ON SCREEN SET.
2, 8, 4, and 6 buttons on the 10 keys work as $\Delta / \nabla / \triangleleft / \triangleright$ for ON SCREEN operations.
2. Press any one of $\Delta / \nabla / \triangleleft / \triangleright$.
The MAIN MENU appears on the TV.
3. Press Δ / ∇ to move \leftarrow to “SOUND CONTROL,” then press $\triangleleft / \triangleright$.
The SOUND CONTROL menu appears.
4. Press Δ / ∇ to move \leftarrow to “BASS BOOST.”
5. Press $\triangleleft / \triangleright$ to turn the Bass Boost function “ON” or “OFF.”
6. When you finish, press ON SCREEN EXIT repeatedly until the menu disappears from the TV.

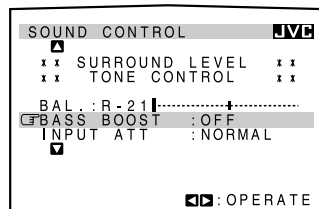

Attenuating the Input Signal (Also see page 10)

1. Press ON SCREEN SET.
2, 8, 4, and 6 buttons on the 10 keys work as $\Delta / \nabla / \triangleleft / \triangleright$ for ON SCREEN operations.
2. Press any one of $\Delta / \nabla / \triangleleft / \triangleright$.
The MAIN MENU appears on the TV.
3. Press Δ / ∇ to move \leftarrow to “SOUND CONTROL,” then press $\triangleleft / \triangleright$.
The SOUND CONTROL menu appears.
4. Press Δ / ∇ to move \leftarrow to “INPUT ATT.”
5. Press $\triangleleft / \triangleright$ to turn the Input Attenuator mode “ATT ON” or “NORMAL.”
6. When you finish, press ON SCREEN EXIT repeatedly until the menu disappears from the TV.

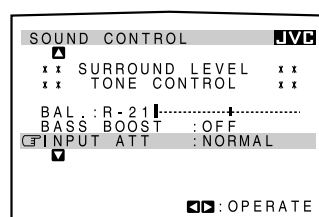

Adjusting the DSP Modes (Also see pages 17 – 19)

1. Press ON SCREEN SET.
2, 8, 4, and 6 buttons on the 10 keys work as $\Delta / \nabla / \triangleleft / \triangleright$ for ON SCREEN operations.
2. Press any one of $\Delta / \nabla / \triangleleft / \triangleright$.
The MAIN MENU appears on the TV.
3. Press Δ / ∇ to move \leftarrow to “MODE.”
4. Press $\triangleleft / \triangleright$ to select the DSP mode you want to adjust.
 - In this example, “THEATER” is selected.
5. Press Δ / ∇ to move \leftarrow to “SOUND CONTROL,” then press $\triangleleft / \triangleright$.
The SOUND CONTROL menu appears.
6. Press Δ / ∇ to move \leftarrow to “SURROUND LEVEL,” then press $\triangleleft / \triangleright$.
The SURROUND LEVEL menu appears.
7. Press Δ / ∇ to move \leftarrow to the item you want to set or adjust, then press $\triangleleft / \triangleright$.

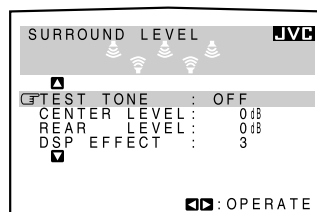
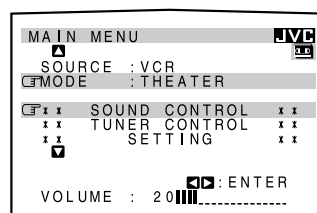
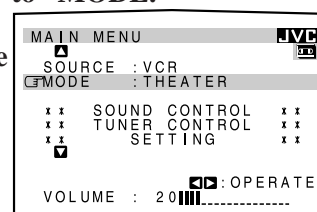

On these adjustment menus, you can do the following:

For 3D-PHONIC (3D ACTION, 3D THEATER):

“DSP EFFECT”: Select the effect level.

For DAP (LIVE CLUB, DANCE CLUB, HALL, PAVILION):

“REAR LEVEL”: Adjust the rear speaker output level.*

“DSP EFFECT”: Select the effect level.

For Dolby Pro Logic:

“TEST TONE”: Output a test tone.

“CENTER LEVEL”: Adjust the center speaker output level.**

“REAR LEVEL”: Adjust the rear speaker output level.*

For JVC Theater Surround:

“TEST TONE”: Output a test tone.

“CENTER LEVEL”: Adjust the center speaker output level.**

“REAR LEVEL”: Adjust the rear speaker output level.

“DSP EFFECT”: Select the effect level.

Notes:

* Not displayed when “REAR SPK” is set to “NO” (see page 11).

** Not displayed when “CENTER SPK” is set to “NONE” (see page 11).

8. When you finish, press ON SCREEN EXIT repeatedly until the menu disappears from the TV.

■ Adjusting the DVD MULTI Playback Mode (Also see page 20)

1. Press ON SCREEN SET.

2, 8, 4, and 6 buttons on the 10 keys work as $\Delta / \nabla / \triangleleft / \triangleright$ for ON SCREEN operations.

2. Press any one of $\Delta / \nabla / \triangleleft / \triangleright$.

The MAIN MENU appears on the TV.

3. Press Δ / ∇ to move \square to "SOURCE."

4. Press $\triangleleft / \triangleright$ to select "DVD MULTI."

5. Press Δ / ∇ to move \square to "SOUND CONTROL," then press $\triangleleft / \triangleright$.

The SOUND CONTROL menu appears.

6. Press Δ / ∇ to move \square to "SURROUND LEVEL," then press $\triangleleft / \triangleright$.

The SURROUND LEVEL menu appears.

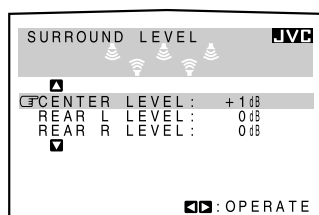

7. Press Δ / ∇ to move \square to the item you want to set or adjust, then press $\triangleleft / \triangleright$.

On this adjustment menus, you can do the following:

"CENTER LEVEL": Adjust the center speaker output level.

"REAR L LEVEL": Adjust the left rear speaker output level.

"REAR R LEVEL": Adjust the right rear speaker output level.

8. When you finish, press ON SCREEN EXIT repeatedly until the menu disappears from the TV.

■ Adjusting the Tone (Also see page 10)

1. Press ON SCREEN SET.

2, 8, 4, and 6 buttons on the 10 keys work as $\Delta / \nabla / \triangleleft / \triangleright$ for ON SCREEN operations.

2. Press any one of $\Delta / \nabla / \triangleleft / \triangleright$.

The MAIN MENU appears on the TV.

3. Press Δ / ∇ to move \square to "SOUND CONTROL," then press $\triangleleft / \triangleright$.

The SOUND CONTROL menu appears.

4. Press Δ / ∇ to move \square to "TONE CONTROL," then press $\triangleleft / \triangleright$.

The TONE CONTROL menu appears.

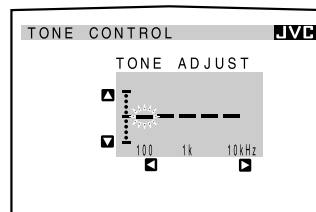

5. Press $\Delta / \nabla / \triangleleft / \triangleright$ to adjust the tone as you want.

$\triangleleft / \triangleright$: Select the frequency ranges — 100 Hz (bass) and 10 kHz (treble).

Δ / ∇ : Adjust the frequency levels.

6. When you finish, press ON SCREEN EXIT repeatedly until the menu disappears from the TV.

■ Setting the Basic Setting Items (Also see pages 11 and 12)

1. Press ON SCREEN SET.

2, 8, 4, and 6 buttons on the 10 keys work as $\Delta / \nabla / \triangleleft / \triangleright$ for ON SCREEN operations.

2. Press any one of $\Delta / \nabla / \triangleleft / \triangleright$.

The MAIN MENU appears on the TV.

3. Press Δ / ∇ to move \square to "SETTING," then press $\triangleleft / \triangleright$.

The SETTING menu appears.

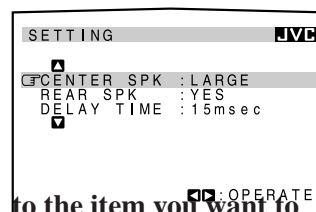

4. Press Δ / ∇ to move \square to the item you want to set or adjust, then press $\triangleleft / \triangleright$.

On the SETTING menu, you can do the following:

"CENTER SPK": Select an appropriate center speaker size.

"REAR SPK": Set the rear speaker information.

"DELAY TIME": Select an appropriate delay time. *

Note:

* Only valid for "PRO LOGIC." Not displayed when "REAR SPK" is set to "NO."

5. When you finish, press ON SCREEN EXIT repeatedly until the menu disappears from the TV.

■ Operating the Tuner (Also see pages 13 and 14)

1. Press ON SCREEN SET.

2, 8, 4, and 6 buttons on the 10 keys work as $\Delta / \nabla / \triangleleft / \triangleright$ for ON SCREEN operations.

2. Press any one of $\Delta / \nabla / \triangleleft / \triangleright$.

The MAIN MENU appears on the TV.

3. Press Δ / ∇ to move \leftarrow to “TUNER CONTROL,” then press $\triangleleft / \triangleright$.

The TUNER CONTROL menu appears.

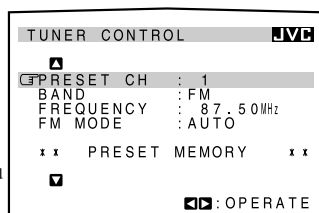

4. Press Δ / ∇ to move \leftarrow to the item you want to set or adjust, then press $\triangleleft / \triangleright$.

On the TUNER CONTROL menu, you can do the following:

- “PRESET CH”: Select a preset channel station.
- “BAND”: Select the band.
- “FREQUENCY”: Tune in a station manually.
- “FM MODE”: Select the FM reception mode.*
- “PRESET MEMORY”: See “Storing the Preset Stations” below.

Note:

* Not displayed when an AM station is selected.

5. When you finish, press ON SCREEN EXIT repeatedly until the menu disappears from the TV.

■ Storing the Preset Stations (Also see page 13)

1. Press ON SCREEN SET.

2, 8, 4, and 6 buttons on the 10 keys work as $\Delta / \nabla / \triangleleft / \triangleright$ for ON SCREEN operations.

2. Press any one of $\Delta / \nabla / \triangleleft / \triangleright$.

The MAIN MENU appears on the TV.

3. Press Δ / ∇ to move \leftarrow to “TUNER CONTROL,” then press $\triangleleft / \triangleright$.

The TUNER CONTROL menu appears.

4. Tune into a station on the TUNER CONTROL menu, referring to “Operating the Tuner” above.

5. Press Δ / ∇ to move \leftarrow to “PRESET MEMORY,” then press $\triangleleft / \triangleright$.

The PRESET MEMORY menu appears.

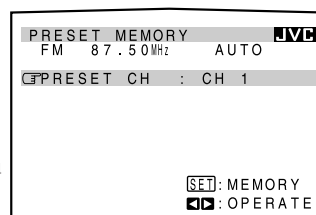

6. Press $\triangleleft / \triangleright$ to select a preset station number you want.

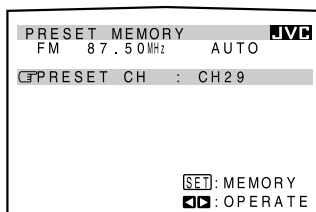

7. Press ON SCREEN SET to store the setting.

8. When you finish, press ON SCREEN EXIT repeatedly until the menu disappears from the TV.

COMPU LINK Remote Control System

The COMPU LINK remote control system allows you to operate JVC audio components through the remote sensor on the receiver.

To use this remote control system, you need to connect JVC audio components through the COMPU LINK-3 (SYNCHRO) jacks (see below) in addition to the connections using cables with RCA pin plugs (see page 5).

- Make sure that the AC power cords of these components are unplugged before connection. Plug the AC power cords only after all connections are complete.

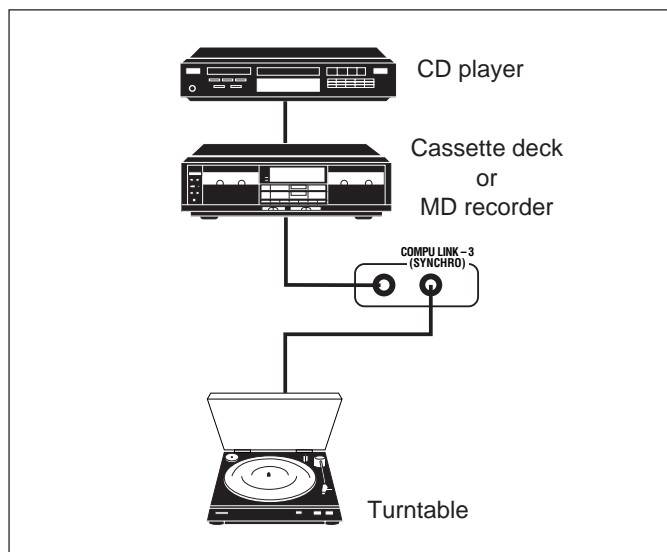

Notes:

- If your audio component has two COMPU LINK-3 (SYNCHRO) jacks, you can use either one. If it has only one COMPU LINK-3 (SYNCHRO) jack, connect it so that it is the last item in the series of components. (For example, the turntable or CD player in the diagram above.)
- To operate the cassette deck or MD recorder using the COMPU LINK remote control system, set the source name correctly. (See page 11.)
- Refer also to the manuals supplied with your audio components.

This remote control system allows you to use four functions listed below.

Remote Control through the Remote Sensor on the Receiver

You can control the connected audio components through the remote sensor on the receiver using this remote control. Aim the remote control directly at the remote sensor on the receiver. For details, see pages 31 and 32.

Automatic Source Selection

When you press the play (▶) button on a connected component or on its own remote control, the receiver automatically turns on and changes the source to the component. On the other hand, if you select a new source on the receiver or the remote control, the selected component begins playing immediately.

In both cases, the previously selected source continues playing without sound for a few seconds.

Automatic Power On/Off (Standby): only possible with the COMPU LINK-3 connection

Both the CD player and cassette deck (or MD recorder) turn on and off (standby) along with the receiver.

When you turn on the receiver, the CD player or cassette deck (or MD recorder) will turn on automatically, depending on which component has been previously selected.

When you turn off the receiver, both the CD player and cassette deck (or MD recorder) will turn off (standby).

Synchronized Recording

Synchronized recording means the cassette deck (or MD recorder) starts recording as soon as a CD or a record begins playing.

To use synchronized recording, follow these steps:

1. Put a tape in the cassette deck (or an MD in the MD recorder), and a disc in the CD player (or a record on the turntable).
2. Press the record (●) button and the pause (II) button on the cassette deck (or MD recorder) at the same time.

This puts the cassette deck (or MD recorder) into recording pause.

If you do not press the record (●) button and pause (II) button at the same time, the synchronized recording feature will not operate.

3. Press the play (▶) button on the CD player or on the turntable.

The source changes on the receiver, and as soon as play starts, the cassette deck (or MD recorder) starts recording. When the play ends, the cassette deck (or MD recorder) enters recording pause, and stops about 4 seconds later.

Notes:

- During synchronized recording, the selected source cannot be changed.
- If the power of any component is shut off during synchronized recording, the COMPU LINK remote control system may not operate properly. In this case, you must start again from the beginning.

TEXT COMPU LINK Remote Control System

The TEXT COMPU LINK remote control system has been newly developed to deal with the disc information recorded in the CD Text* and MDs. Using these information in the discs, you can operate the CD player or MD recorder equipped with the TEXT COMPU LINK remote control system through the receiver.

CONNECTIONS:

To use this remote control system, you need to connect the CD player and/or MD recorder you want to operate, following the procedures below.

1. If you have already plugged your CD player, MD recorder, and this receiver into the AC outlets, unplug their AC power cords first.
2. Connect your CD player, MD recorder, and this receiver as follows, through the COMPU LINK-3 (SYNCHRO) jacks and TEXT COMPU LINK jacks.

- 1) **COMPU LINK-3 (SYNCHRO) jacks:** Use the cables with the monaural mini-plugs (not supplied with this receiver).

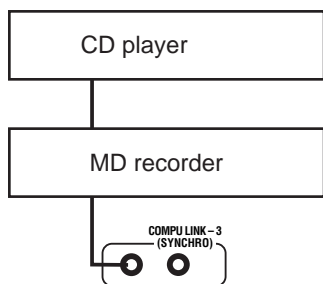

- 2) **TEXT COMPU LINK jacks:** Use the cables with the stereo mini-plugs (not supplied with this receiver).

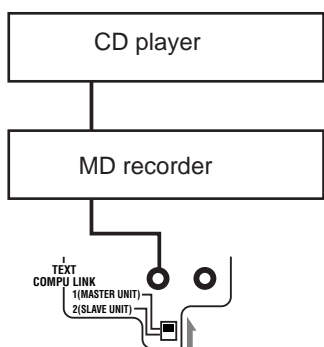

IMPORTANT:

Set the Master/Slave Selector on the rear to "1(MASTER UNIT)."

- "2(SLAVE UNIT)" is just for the serviceman's use. The TEXT COMPU LINK remote control system does not function with the selector set to "2(SLAVE UNIT)."

3. Connect your CD player, MD recorder and this receiver, using the cables with RCA pin plugs (see page 5).
4. Plug the AC power cords of these components above into the AC outlets.
5. When turning on these components for the first time, turn on the connected components first, then turn on this receiver.

FUNCTIONS:

This remote control system allows you to use the functions listed below.

Displaying the Disc Information on the TV screen

Disc information such as its performer and disc title (and track titles only when a CD Text is selected) is shown on the TV screen.

Disc Search: Only for CD Player

This remote control system can allow you to search discs by the performer, disc title, and music genre. With this disc search, you can easily find the disc you want to play.

Disc Title Input:

If your CD player or MD recorder has the disc memory function, you can input the performer, disc title, and music genre about these normal audio CDs or MDs on the TV screen.

***What is a CD Text?**

In a CD Text, some information about the disc (its disc title, performer, composer, arranger, etc.) is recorded.

Notes:

- If your audio component has two COMPU LINK-3 (SYNCHRO) jacks, you can use either one. If it has only one COMPU LINK-3 (SYNCHRO) jack, connect it so that it is the last item in the series of components. (For example, the CD player in the diagram to the left.)
- If your audio component has two TEXT COMPU LINK jacks, you can use either one. If it has only one TEXT COMPU LINK jack, connect it so that it is the last item in the series of components. (For example, the CD player in the diagram to the left.)
- "TEXT COMPULINK SOURCE NOT CONNECTED" appears on the display in the following cases:
 - When the connections explained to the left are not correctly done.
 - When you try to use the TEXT COMPULINK function a few seconds after you turn on the connected equipment. This is not a malfunction of the units.
- Refer also to the manuals supplied with your CD player or MD recorder.

IMPORTANT:

If you turn on the receiver before turning on the other components after connecting components, the TEXT COMPU LINK remote control system does not work correctly.

If this happens:

1. Turn off all the components including this receiver.
2. Turn on the connected components.
3. Turn on this receiver.

OPERATIONS

To use this remote control system, you need to connect the TV to the MONITOR OUT jack on the rear panel (see page 6), and set the TV's input mode to the proper position to which the receiver is connected. **Make sure you have connected the CD player or MD recorder equipped with the TEXT COMPU LINK remote control system. If not, you cannot use the following functions.**

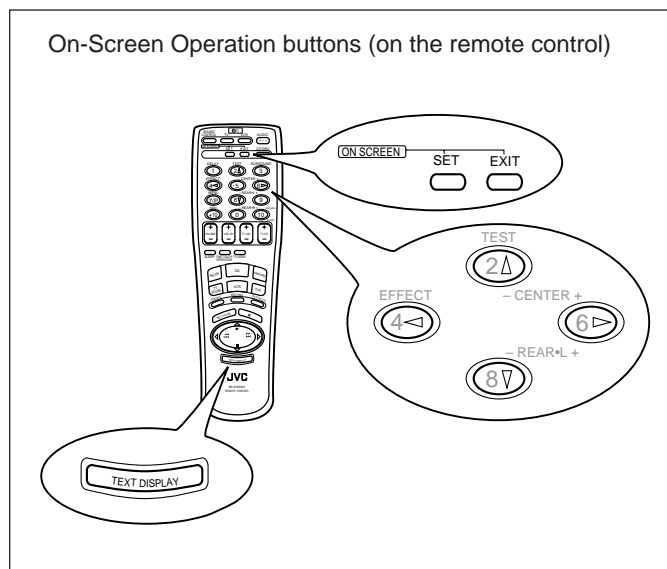

Showing the Disc Information on the TV Screen

Press **TEXT DISPLAY** while "CD" or "MD" is selected as the source.

The Disc Information screen appears on the TV.

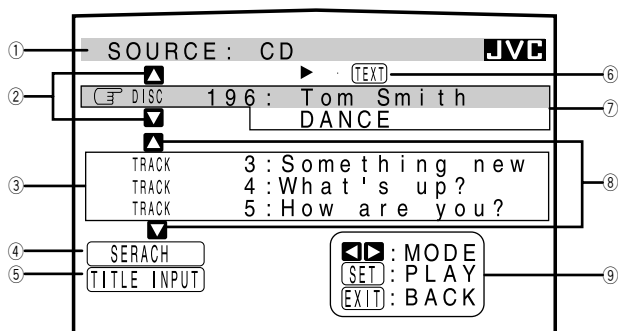

- ① Source name: CD or MD
- ② Select **▲** or **▼**, then press ON SCREEN SET to change the disc.
- ③ Track numbers and track titles.
 - The current playing (selected) track is indicated in yellow.
 - When you move **↔** to a track number, you can change the track information by pressing **</>**. Each time you press the button, track information alternates between its track title and its performer. (You can also start playing the track by pressing ON SCREEN SET.)
- ④ Select this (move **↔** in front), then press ON SCREEN SET to go to the DISC SEARCH screen (see page 28).
- ⑤ Select this (move **↔** in front), then press ON SCREEN SET to go to the TITLE INPUT screen (see page 29).
- ⑥ This appears only when a CD Text is selected.
- ⑦ Disc information such as the disc title, performer, and music genre.

When this is selected (**↔** in front), you can change the disc information by pressing **</>**. Each time you press the button, disc information (see "Note on ⑦") changes.
- ⑧ Select **▲** or **▼**, then press ON SCREEN SET to change the track.
- ⑨ Usable buttons and their functions for the current selection.

Indication here will be changed according to what is currently selected (**↔** in front) on the screen. See "Note on ⑨."

Note on ⑦:

The following information will appear on the display:

- Disc title
- Performer
- Genre
- Song writer
- Composer
- Arranger
- Message

Only recorded information will be shown. If there is no data, "NO DATA" will appear.

Note on ⑨:

For example, the ON SCREEN SET button will be used to start play (PLAY), to go to the next screen (ENTER), and to determine the selection (ENTER).

To exit from the Disc information screen:

Press ON SCREEN EXIT.

Notes:

- The on-screen display will disappear in the following case:
 - if no operation is done for about 10 minutes.
 - if you do any operation other than explained in this section.
- To control the MD recorder using the TEXT COMPU LINK remote control system, you have to change the source name shown on the display from "TAPE" to "MD." (See page 11.)
- Some special characters and marks cannot be displayed correctly.

■ Searching a Disc (Only for the CD player)

Search a disc by its performer:

1. Press TEXT DISPLAY while “CD” is selected as the source.

The Disc Information screen appears on the TV.

2. Press Δ / ∇ to move \leftarrow to “SEARCH,” then press ON SCREEN SET.

The DISC SEARCH screen appears.

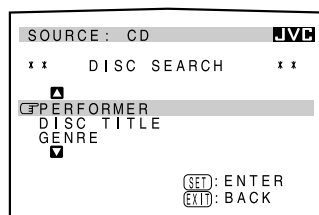

3. Press Δ / ∇ to move \leftarrow to “PERFORMER,” then press ON SCREEN SET.

The PERFORMER SEARCH screen appears.

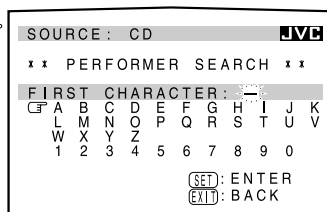

4. Press $\Delta / \nabla / \leftarrow / \rightarrow$ to move \leftarrow in front of the first character of the performer you want to search, then press ON SCREEN SET.

To correct the incorrect entry, press $\Delta / \nabla / \leftarrow / \rightarrow$ to move \leftarrow in front of the correct character, then press ON SCREEN SET.

Note:

Symbols such as @, # or \$ cannot be available for search.

5. Press ON SCREEN SET again.

Disc search starts, then the SEARCH RESULT screen, showing the performers, appears.

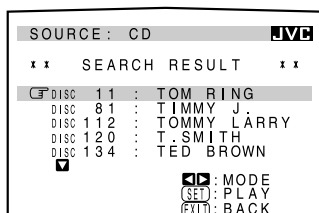

6. On the SEARCH RESULT screen, you can do the following:

- **Changing the indication of the disc information:** Press Δ / ∇ to move \leftarrow to a searched disc, then press \leftarrow / \rightarrow . Each time you press \leftarrow / \rightarrow , the disc information alternates between its performer and its disc title.
- **Going to the Disc Information screen (see page 27):** Press Δ / ∇ to move \leftarrow to a searched disc, then press ON SCREEN SET.
- **Showing unseen disc information (if more than 5 discs are listed as a result of the search):** Press Δ / ∇ until they appear.
- **Going back to the PERFORMER SEARCH screen:** Press ON SCREEN EXIT.

Search a disc by its disc title:

1. Press TEXT DISPLAY while “CD” is selected as the source.

The Disc Information screen appears on the TV.

2. Press Δ / ∇ to move \leftarrow to “SEARCH,” then press ON SCREEN SET.

The DISC SEARCH screen appears.

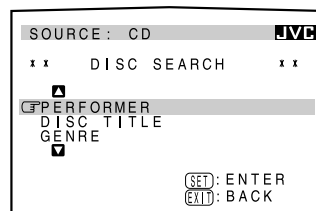

3. Press Δ / ∇ to move \leftarrow to “DISC TITLE,” then press ON SCREEN SET.

The DISC TITLE SEARCH screen appears.

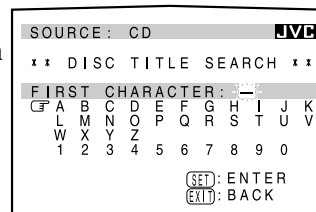

4. Press $\Delta / \nabla / \leftarrow / \rightarrow$ to move \leftarrow in front of the first character of the disc title you want to search, then press ON SCREEN SET.

To correct the incorrect entry, press $\Delta / \nabla / \leftarrow / \rightarrow$ to move \leftarrow in front of the correct character, then press ON SCREEN SET.

Note:

Symbols such as @, # or \$ cannot be available for search.

5. Press ON SCREEN SET again.

Disc search starts, then the SEARCH RESULT screen, showing the disc titles, appears.

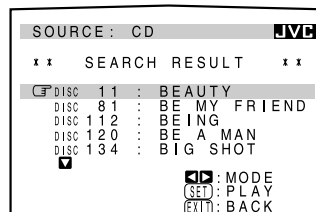

6. On the SEARCH RESULT screen, you can do the following:

- **Changing the indication of the disc information:** Press Δ / ∇ to move \leftarrow to a searched disc, then press \leftarrow / \rightarrow . Each time you press \leftarrow / \rightarrow , the disc information alternates between its disc title and its performer.
- **Going to the Disc Information screen (see page 27):** Press Δ / ∇ to move \leftarrow to a searched disc, then press ON SCREEN SET.
- **Showing unseen disc information (if more than 5 discs are listed as a result of the search):** Press Δ / ∇ until they appear.
- **Going back to the DISC TITLE SEARCH screen:** Press ON SCREEN EXIT.

Search a disc by its genre:

1. Press TEXT DISPLAY while “CD” is selected as the source.

The Disc Information screen appears on the TV.

2. Press Δ / ∇ to move \leftarrow to “SEARCH,” then press ON SCREEN SET.

The DISC SEARCH screen appears.

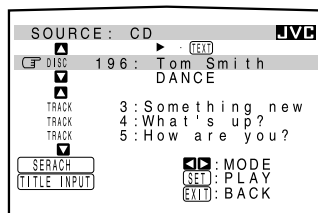

3. Press Δ / ∇ to move \leftarrow to “GENRE”, then press ON SCREEN SET.

The GENRE SEARCH screen appears.

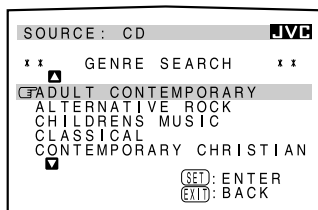

4. Press Δ / ∇ to move \leftarrow to the genre you want to search, then press ON SCREEN SET.

To show the unseen genres, press Δ / ∇ until they appear.

Disc search starts, then the SEARCH RESULT screen, showing the disc titles, appears.

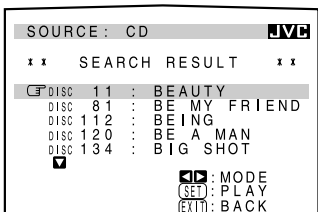

5. On the SEARCH RESULT screen, you can do the following:

- **Changing the indication of the disc information:** Press Δ / ∇ to move \leftarrow to a searched disc, then press \triangleleft / \triangleright . Each time you press \triangleleft / \triangleright , the disc information alternates between its disc title and its performer.
- **Going to the Disc Information screen (see page 27):** Press Δ / ∇ to move \leftarrow to a searched disc, then press ON SCREEN SET.
- **Showing unseen disc information (if more than 5 discs are listed as a result of the search):** Press Δ / ∇ until they appear.
- **Going back to the GENRE SEARCH screen:** Press ON SCREEN EXIT.

Entering the Disc Information**For the CD Player with the disc memory function:**

You can use the disc memory function through this receiver.

The disc information (its performer, disc title, and music genre) of normal audio CDs will be stored into the memory built in the CD player.

For the disc memory function, refer to the manual supplied with your CD player.

- The performer, disc title, and music genre information are usually recorded in a CD Text. However, if a CD Text has no genre information recorded in the disc itself, you can input its music genre by yourself.

Note:

You can enter the TITLE INPUT screens for a CD Text and input its titles. However, you cannot store the titles you have input for a CD Text.

Example: Entering the following information for Disc 1
Performer: “MICHEAL”
Disc title: “MY FAVORITE”

1. Press TEXT DISPLAY while “CD” is selected as the source.

The Disc Information screen appears on the TV.

2. Press Δ / ∇ to move \leftarrow to “TITLE INPUT,” then press ON SCREEN SET.

The TITLE INPUT:

PERFORMER screen appears.

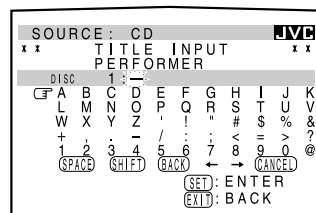

3. Press Δ / ∇ / \triangleleft / \triangleright to move \leftarrow in front of a character you want, then press ON SCREEN SET to enter the character.

- If the current CD is a CD Text, go to step 5 without entering the performer.

To use the lower case letters, press Δ / ∇ / \triangleleft / \triangleright to move \leftarrow to [SHIFT], then press ON SCREEN SET.

To use the upper case letters again, press Δ / ∇ / \triangleleft / \triangleright to move \leftarrow to [SHIFT], then press ON SCREEN SET.

4. Repeat step 3 until you finish putting a name (up to 32 characters).

To insert a space, press Δ / ∇ / $\triangleleft / \triangleright$ to move C to SPACE , then press ON SCREEN SET.

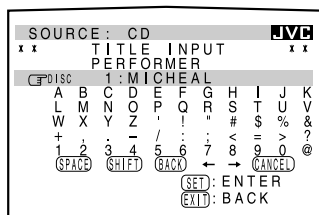

To correct an incorrect character:

- 1) Press Δ / ∇ / $\triangleleft / \triangleright$ to move C to \leftarrow or \rightarrow , then press ON SCREEN SET until the incorrect character is selected.
- 2) Press Δ / ∇ / $\triangleleft / \triangleright$ to move C to CANCEL, then press ON SCREEN SET to erase the character.
- 3) Press Δ / ∇ / $\triangleleft / \triangleright$ to move C in front of the correct character, then press ON SCREEN SET to enter a correct character.

5. Press Δ / ∇ / $\triangleleft / \triangleright$ to move C to "DISC 1: MICHEAL (in this example)," then press ON SCREEN SET.

The TITLE INPUT: DISC TITLE screen appears.

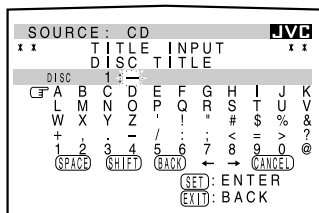

6. Enter the disc title, referring to steps 3 and 4.

- If the current CD is a CD Text, go to the next step without entering the disc title.

7. Press Δ / ∇ / $\triangleleft / \triangleright$ to move C to "DISC 1: MY FAVORITE (in this example)," then press ON SCREEN SET.

The TITLE INPUT: DISC 1 GENRE screen appears.

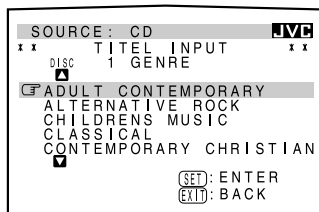

8. Press Δ / ∇ to move C to the genre you want, then press ON SCREEN SET.

The Disc Information screen appears again.

To show the unseen genres, press Δ / ∇ until they appear.

For the MD recorder:

You can write the disc information (disc title and song titles) into the disc. You can only write the song title for the song currently selected.

- If you have the CD-MD combination deck, you can also enter the disc information (its performer, disc title, and its music genre) of normal audio CDs into the memory built in the CD-MD combination deck. (To do this, follow the procedure of "For the CD Player with the disc memory function" to the left.)

1. Press TEXT DISPLAY while "MD" is selected as the source.

The Disc Information screen appears on the TV.

2. Press Δ / ∇ to move C to "TITLE INPUT," then press ON SCREEN SET.

The DISC TITLE INPUT screen appears.

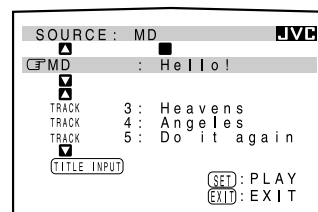

3. Enter the title, referring to steps 3 and 4 of "For the CD Player with the disc memory function" to the left.

- You can enter up to 32 characters for the disc title.

4. Press Δ / ∇ / $\triangleleft / \triangleright$ to move C to the disc title you have just entered, then press ON SCREEN SET.

The disc title is stored into the memory, and the SONG TITLE INPUT screen for the currently selected song appears.

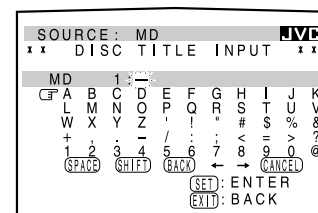

- You can enter a song title for the song currently selected (indicated in yellow on the TV screen).

5. Enter the song title, referring to steps 3 and 4 of "For the CD Player with the disc memory function" to the left.

- You can enter up to 32 characters for the song title.

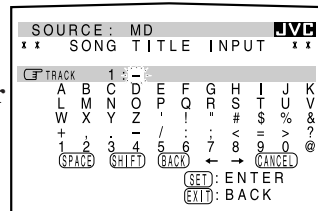

6. Press Δ / ∇ / $\triangleleft / \triangleright$ to move C to the song title you have just entered, then press ON SCREEN SET.

The song title is stored into the memory, and the Disc Information screen appears again.

Operating JVC's Audio/Video Components

You can operate JVC's audio and video components with this receiver's remote control, since control signals for JVC components are preset in the remote control.

IMPORTANT:

To operate JVC's audio components using this remote control:

- You need to connect JVC audio components through the COMPU LINK-3 (SYNCHRO) jacks (see page 25) in addition to the connections using cables with RCA pin plugs (see page 5).
- Aim the remote control directly at the remote sensor on the receiver.
- If you use the buttons on the front panel or the menu function to choose a source, the remote control will not operate that source. To operate a source with the remote control, the source must be selected using buttons on the remote control.
- Refer also to the manuals supplied with your components.

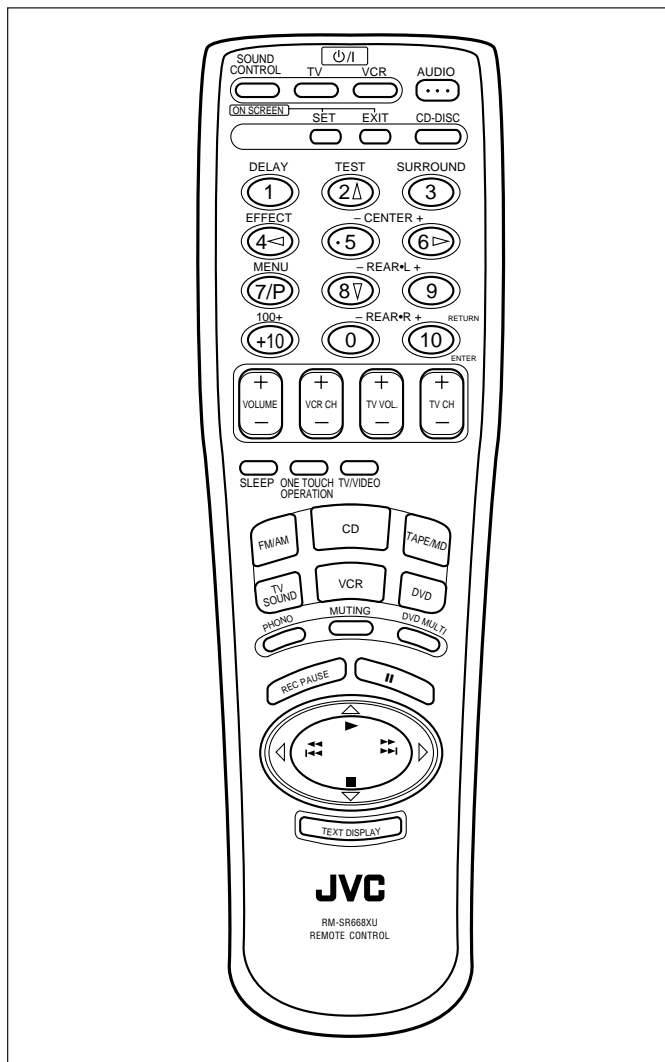

Tuner

After pressing FM/AM, you can perform the following operations:

- FM/AM: Alternates between FM and AM.
1 – 10, +10: Selects a preset channel number directly.
For channel number 5, press 5.
For channel number 15, press +10, then 5.
For channel number 20, press +10, then 10.

Sound control section (Amplifier)

After pressing SOUND CONTROL, you can perform the following operations:

- SURROUND: Selects the DSP modes.
CENTER – / +: Adjusts the center speaker output level for the Surround/DVD MULTI playback modes.
REAR•L – / +: Adjusts the left/right rear speaker output level for the DSP modes.
Adjusts the left rear speaker output level for the DVD MULTI playback mode.
REAR•R – / +: Adjusts the right rear speaker output level for the DVD MULTI playback mode.
DELAY: Selects the delay time of the rear speaker sound. (Only works when "PRO LOGIC" is selected.)
EFFECT: Selects the effect level for the DSP modes.
TEST: Turns on or off the test tone output for the Surround mode.

Note:

After adjusting sounds, press the corresponding source selecting button or CD-DISC to operate your target source by using 10 keys; otherwise, 10 keys cannot be used for operating your target source.

CD player

After pressing CD, you can perform the following operations on the CD player:

- ▶: Starts playing.
◀◀: Returns to the beginning of the current (or previous) track.
▶▶: Skips to the beginning of the next track.
■: Stops playing.
||: Pauses playing. To release it, press ▶.
1 – 10, +10: Selects a track number directly.
For track number 5, press 5.
For track number 15, press +10, then 5.
For track number 20, press +10, then 10.
For track number 30, press +10, +10, then 10.

CD player-changer

After pressing CD-DISC, you can perform the following operations on a CD player-changer:

- ▶: Starts playing.
◀◀: Returns to the beginning of the current (or previous) track.
▶▶: Skips to the beginning of the next track.
■: Stops playing.
||: Pauses playing. To release it, press ▶.
1 – 6, 7/P: Select the number of a disc installed in a CD player-changer.

After pressing CD, you can perform the following operations on the CD player-changer:

- 1 – 10, +10: Selects a track number directly.
For track number 5, press 5.
For track number 15, press +10, then 5.
For track number 20, press +10, then 10.
For track number 30, press +10, +10, then 10.

Cassette deck

After pressing TAPE/MD, you can perform the following operations on a cassette deck:

- ▶: Starts playing.
- ◀◀: Fast winds the tape from right to left.
- ▶▶: Fast winds the tape from left to right.
- : Stops operations.
- ⏸: Pauses playing. To release it, press ▶.
- REC PAUSE: Pauses recording temporarily. To release it, press ▶.

Note:

To operate the cassette deck or MD recorder using the COMPU LINK remote control system, set the source name correctly. (See page 11.)

MD recorder

After pressing TAPE/MD, you can perform the following operations on the MD recorder:

- ▶: Starts playing.
- ◀◀: Returns to the beginning of the current (or previous) track.
- ▶▶: Skips to the beginning of the next track.
- : Stops playing.
- ⏸: Pauses playing. To release it, press ▶.
- REC PAUSE: Pauses recording temporarily. To release it, press ▶.

Note:

To operate the cassette deck or MD recorder using the COMPU LINK remote control system, set the source name correctly. (See page 11.)

IMPORTANT:

To operate JVC's video components using this remote control:

- Aim the remote control directly at the remote sensor on the VCR, DVD player or TV, not on the receiver.
- Some JVC VCRs can accept two types of the control signals — remote code "A" and "B." Before using this remote control, make sure that the remote control code of the VCR connected to the VCR jacks is set to code "A."

VCR

You can always perform the following operations:

- VCR \odot/I : Turns on or off the VCR.
- VCR CH +/-: Changes the channels on the VCR.

After pressing VCR, you can perform the following operations on the VCR:

- ▶: Starts playing.
- ◀◀: Rewinds a tape.
- ▶▶: Fast winds a tape.
- : Stops operations.
- ⏸: Pauses playing. To release it, press ▶.
- REC PAUSE: Pauses recording temporarily. To release it, press ▶.

DVD player

After pressing DVD or DVD MULTI, you can perform the following operations on a DVD player:

- ▶: Starts playing.
- ◀◀: Returns to the beginning of the current (or previous) track.
- ▶▶: Skips to the beginning of the next track.
- : Stops playing.
- ⏸: Stops playing temporarily. To release it, press ▶.

After pressing DVD or DVD MULTI, these buttons can be used for the DVD menu operations.

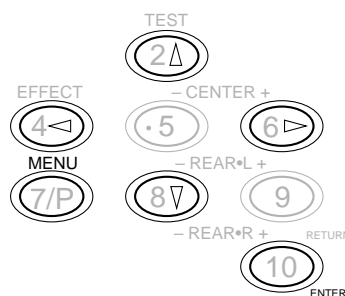
**Note:**

For detailed menu operations, refer to the instructions supplied with the discs or the DVD player.

TV

You can always perform the following operations:

- TV \odot/I : Turns on or off the TV.
- TV VOL. +/-: Adjusts the volume.
- TV/VIDEO: Sets the input mode (either TV or VIDEO).
- TV CH +/-: Changes the channels.

After pressing TV SOUND, you can perform the following operations on a TV:

- 1 – 9, 0, 100+: Selects the channels.
- RETURN: Alternates between the previously selected channel and the current channel.

Troubleshooting

Use this chart to help you solve daily operational problems. If there is any problem you cannot solve, contact your JVC service center.

PROBLEM	POSSIBLE CAUSE	SOLUTION
The display does not light up.	The power cord is not plugged in.	Plug the power cord into an AC outlet.
No sound from speakers.	Speaker signal cables are not connected.	Check speaker wiring and reconnect if necessary.
	The SPEAKERS 1 and 2 buttons are not set correctly.	Press SPEAKERS 1 and 2 correctly.
	An incorrect source is selected.	Select the correct source.
	Muting is activated.	Press MUTING to cancel the mute.
Sound from one speaker only.	Speaker signal cables are not connected properly.	Check speaker wiring and reconnect if necessary.
	The balance is set to one extreme.	Adjust the balance properly (see page 10).
Continuous hiss or buzzing during FM reception.	Incoming signal is too weak.	Connect an outside FM antenna or contact your dealer.
	The station is too far away.	Select a new station.
	An incorrect antenna is used.	Check with your dealer to be sure you have the correct antenna.
	Antennas are not connected properly.	Check connections.
Occasional cracking noise during FM reception.	Ignition noise from automobiles.	Move the antenna farther from automobile traffic.
No colors on the on-screen display.	The color system of the connected TV is not PAL.	Connect a PAL TV.
Howling during record playing.	Your turntable is too close to speakers.	Move speakers away from the turntable.
"OVERLOAD" starts flashing on the display.	Speakers are overloaded because of high volume.	Rotate the MASTER VOLUME control counterclockwise three or four times, then press STANDBY/ON $\cup/ $ on the front panel. If "OVERLOAD" does not disappear, unplug the AC power cord, then plug it back again.
	Speakers are overloaded because of short circuit of speaker terminals.	Press STANDBY/ON $\cup/ $ on the front panel, then check the speaker wiring. If "OVERLOAD" does not disappear, unplug the AC power cord, then plug it back again. If speaker wiring is not short-circuited, contact your dealer.
Remote control does not work.	There is an obstruction in front of the remote sensor on the receiver.	Remove the obstruction.
	Batteries are weak.	Replace batteries.

Amplifier

Output Power

At Stereo operation: 100* watts per channel, min. RMS, driven into 8 ohms, at 1 kHz with no more than 0.9 % total harmonic distortion. (IEC268-3/DIN)

At Surround operation:

Front Channels: 80* watts per channel, min. RMS, driven into 4 ohms at 1 kHz with no more than 0.8 % total harmonic distortion.

Center channel: 80* watts, min. RMS, driven into 4 ohms at 1 kHz, with no more than 0.8 % total harmonic distortion.

Rear channels: 80* watts per channel, min. RMS, driven into 4 ohms at 1 kHz, with no more than 0.8 % total harmonic distortion.
(* Measured on AC 110V, 127V, 220V, and 240V)

Total Harmonic Distortion (8 ohms, 1 kHz):

0.8%** at 100 watts output

(** Measured by JVC Audio Analysis System, on AC 110V, 127V, 220V, and 240V)

Audio

Audio Input Sensitivity/Impedance (1 kHz):

PHONO (MM): 2.7 mV/47 k ohms

CD, TAPE/MD, TV SOUND, VCR, DVD:
220 mV/47 k ohms

Audio Output Level: TAPE/MD, VCR 220 mV

Signal-to-Noise Ratio (*66 IHF/DIN):

PHONO: 70 dB/66 dB

CD, TAPE/MD, TV SOUND, VCR, DVD:
87 dB/67 dB

Frequency Response (8 ohms)

PHONO: 20 Hz to 20 kHz (± 1 dB)

CD, TAPE/MD, TV SOUND, VCR, DVD:
20 Hz to 20 kHz (± 1 dB)

RIAA Phono Equalization: ± 1 dB (20 Hz to 20 kHz)

Video

Video Input Sensitivity/Impedance:

Composite video: VCR, DVD:

1 V_{p-p}/75 ohms

S-video: DVD (Y: luminance): 1 V_{p-p}/75 ohms

(C: chrominance, burst): 0.286 V_{p-p}/75 ohms

Video Output Level:

Composite video: VCR, MONITOR OUT

1 V_{p-p}/75 ohms

S-video: MONITOR OUT

(Y: luminance): 1 V_{p-p}/75 ohms

(C: chrominance, burst): 0.286 V_{p-p}/75 ohms

Synchronization: Negative

Signal-to-Noise Ratio: 45 dB

On-Screen Color System: PAL

FM tuner (IHF)

Tuning Range: 87.50 MHz to 108.00 MHz

Usable Sensitivity: Monaural: 17.0 dBf (1.95 μ V/75 ohms)

50 dB Quieting Sensitivity

Monaural 21.3 dBf (3.2 μ V/75 ohms)

Stereo 41.3 dBf (31.5 μ V/75 ohms)

Signal-to-Noise Ratio (IHF-A weighted)

Monaural 78 dB at 85 dBf

Stereo 73 dB at 85 dBf

Total Harmonic Distortion:

Monaural 0.4 % at 1 kHz

Stereo 0.6 % at 1 kHz

Stereo Separation at REC OUT: 35 dB at 1 kHz

Alternate Channel Selectivity:

60 dB: (± 400 kHz)

Frequency Response: 30 Hz to 15 kHz: (+0.5 dB, -3 dB)

AM tuner

Tuning Range: 531 kHz to 1,602 kHz (at 9 kHz interval)

530 kHz to 1,600 kHz (at 10 kHz interval)

Usable Sensitivity: Loop antenna 400 μ V/m

Signal-to-Noise Ratio 50 dB (100 mV/m)

General

Power Requirements: AC 110V/127V/220V/230-240V[~],
Adjustable with the voltage selector, 50/
60 Hz

Power Consumption: 250 watts (at operation)
5 watts (in standby mode)

Dimensions (W x H x D): 435 x 146 x 403.5 mm
(17 ³/₁₆ x 5 ³/₄ x 15 ¹⁵/₁₆ inches)

Mass: 10.2 kg (22.5 lbs)

Designs & specifications are subject to change without notice.

Mains (AC) Line Instruction (not applicable for Europe, U.S.A., Canada, Australia and U.K.)

Instrucción sobre la línea de la red (CA) (no aplicable para Europa, EE.UU., Canadá, Australia, ni el Reino Unido)

Instrução sobre a tensão da rede eléctrica (CA) (não aplicável para a Europa, os E.U.A., o Canadá, a Austrália e o Reino Unido)

主 (AC) 电源线路说明 (不适用于欧洲、美国、加拿大、澳洲及英国型号)

تعليمات التيار الرئيسي (المتردد) (لا ينطبق لاوروبا وامريكا وكندا واستراليا والمملكة المتحدة)

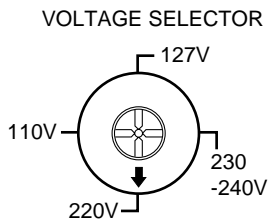
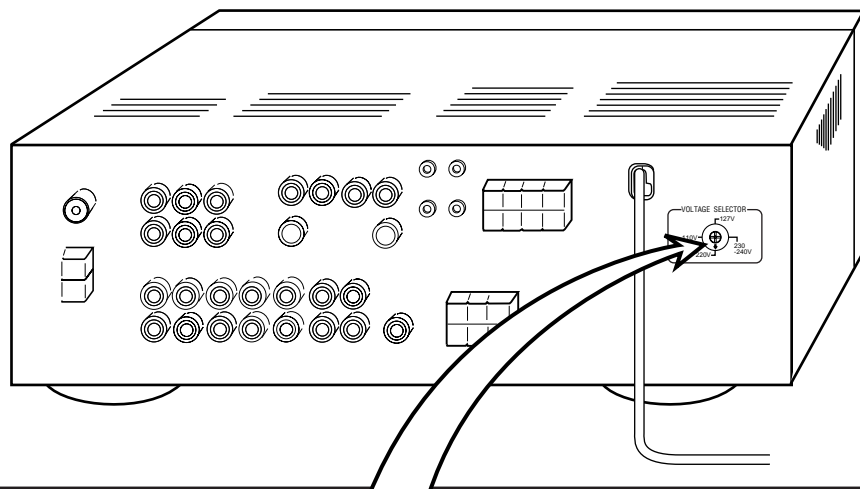

CAUTION for mains (AC) line

BEFORE PLUGGING IN, do check that your mains (AC) line voltage corresponds with the position of the voltage selector switch provided on the outside of this equipment and, if different, reset the voltage selector switch, to prevent from a damage or risk of fire/electric shock.

PRECAUCIÓN para la línea de la red (CA)

ANTES DE ENCHUFAR EL EQUIPO, compruebe si la tensión de la línea de la red (CA) corresponde con la posición del selector de tensión situado en la parte exterior del equipo, y si es diferente, reajuste el selector de tensión para evitar el riesgo de incendios/ descargas eléctricas.

PRECAUÇÃO para a ligação à tensão da rede (CA)

ANTES DE LIGAR O APARELHO A UMA TOMADA DA REDE, verifique se a tensão da rede CA corresponde à posição do selector de voltagem localizado na parte externa deste equipamento. Caso não corresponda, reajuste o selector de voltagem a fim de evitar avarias ou riscos de incêndio e choque eléctrico.

有关主 (AC) 电源线路的注意事项

接插电源以前，务请检查当地的主 (AC) 电源线路电压是否和位于本机外面的电压选择开关设定的位置一致。如果不一致，即重新设定电压选择开关使符合当地电压，以免损坏机器或引起火灾 / 触电的危险。

هام من أجل خط التيار المتردد (AC) الرئيسي

قبل ادخال القابس، تأكد من أن فولطية خط التيار المتردد (AC) الرئيسي لديك متوافقة مع موضع مفتاح اختيار الفولطية المتوفر خارج هذه المعدات وإذا اختلفت، فقم باعادة ضبط مفتاح اختيار الفولطية، لمنع التلف أو الصدمة الكهربائية وخطر الحريق.

JVC

VICTOR COMPANY OF JAPAN, LIMITED